

**Anritsu** envision : ensure

# Network Master™ Series

## Network Master Pro MT1000A

10G Multirate Module MU100010A

100G Multirate Module MU100011A

High Performance GPS Disciplined Oscillator MU100090A

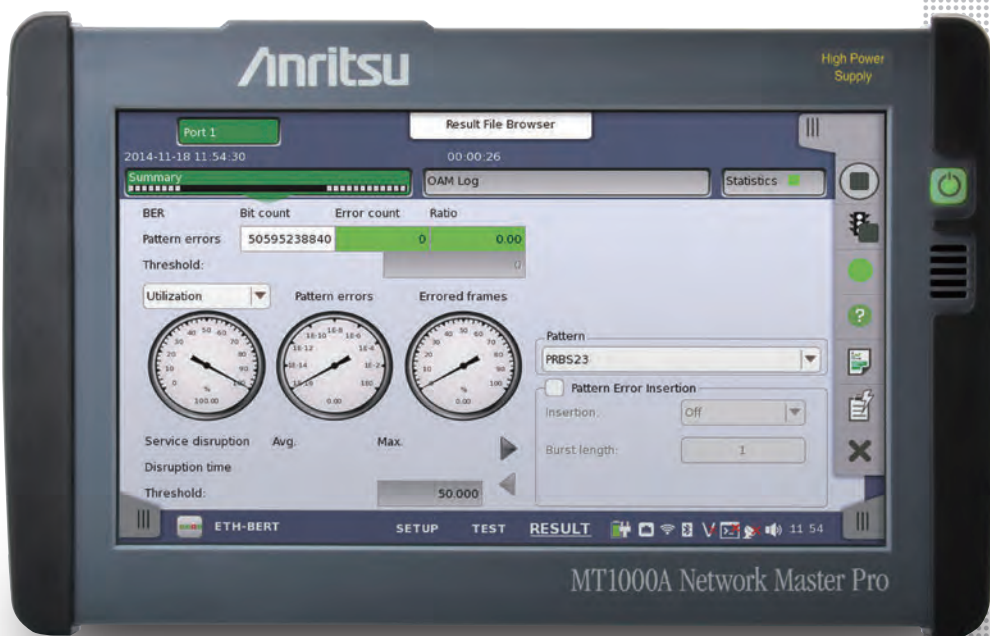

# All-in-One Tester for Network

Networks continue to evolve as standards for transport tests, such as Ethernet, OTN, SDH/SONET, eCPRI/RoE/CPRI/OBSAI, PTP, Fibre Channel, etc., become more diverse, and speeds increase with development of 100G/25G Ethernet and 16G Fibre Channel.

With an easily configured modular design to support changing network standards and an easy-to-use GUI, the Network Master Pro MT1000A is perfect for rapid I&M of wide-area networks.



# MT1000A



**All in One**

**I&M**

**Easy to use**

- All transport network field tests in one tester
- Easy-to-read 9-inch touch screen in easy-to-use compact B5-size tester
- Higher work efficiency with multiple tests using one-button automated measurement tools

\* : Available for certified countries and regions including USA, Canada, Japan and EU countries. Please visit the Anritsu web site for updated information.

### Evolving Networks and Required Test Equipment

100G interfaces are being introduced progressively on Core and Metro networks. Additionally, introduction of the eCPRI/RoE protocol is being examined for 5G mobile networks in combination with 5G speed increases and diversifying applications. Onsite network I&M work requires cost-effective support for diversifying services at speeds from 1G to 100G with a field tester that improves work efficiency.

### Key Applications → Details P.6

- |   |  |
|---|--|
| <div style="background-color: #008080; color: white; padding: 5px; text-align: center; font-size: 8px;"> <b>Ethernet</b> </div> <div style="background-color: #008080; color: white; padding: 5px; text-align: center; font-size: 8px;"> <b>100G/25G Ethernet</b> </div>  | <ul style="list-style-type: none"> <li>• 10M to 10G/25G/40G/100G Ethernet testing</li> <li>• FEC testing of 100G/25G Ethernet</li> <li>• High load traffic generation function at full wire rate</li> <li>• Ethernet testing up to 10 Gbps including RFC 2544, RFC 6349 and Y.1564</li> </ul>  |
| <div style="background-color: #008080; color: white; padding: 5px; text-align: center; font-size: 8px;"> <b>Mobile Fronthaul</b> </div> <div style="background-color: #008080; color: white; padding: 5px; text-align: center; font-size: 8px;"> <b>eCPRI</b> </div>      | <ul style="list-style-type: none"> <li>• BER and Latency tests at eCPRI/RoE (IEEE1914.3) frame</li> <li>• Supported to CPRI 1 to 10</li> <li>• Supported to OBSAI 1x, 2x, 4x, 8x</li> <li>• Verifying Link connection with REC/RE using CPRI</li> </ul>  |
| <div style="background-color: #008080; color: white; padding: 5px; text-align: center; font-size: 8px;"> <b>Mobile Backhaul</b> </div> <div style="background-color: #008080; color: white; padding: 5px; text-align: center; font-size: 8px;"> <b>PTP Network</b> </div> | <ul style="list-style-type: none"> <li>• SyncE testing up to 25 Gbps</li> <li>• PTP testing up to 25 Gbps</li> <li>• MU100090A enables easy Pass/Fail evaluations when installing and commissioning time and phase synchronous networks</li> <li>• Supported Profiles:<br/>G.8265.1, G.8375.1, G.8275.2, SMPTE2059-2</li> </ul>                                |
| <div style="background-color: #008080; color: white; padding: 5px; text-align: center; font-size: 8px;"> <b>Data Center</b> </div> <div style="background-color: #008080; color: white; padding: 5px; text-align: center; font-size: 8px;"> <b>Fibre Channel</b> </div>   | <ul style="list-style-type: none"> <li>• Supported to 1GFC, 2GFC, 4GFC, 8GFC, 10GFC, 16GFC</li> <li>• Network Performance Testing</li> <li>• Latency test</li> <li>• BER tests including service disruption measurement</li> </ul>   |
| <div style="background-color: #008080; color: white; padding: 5px; text-align: center; font-size: 8px;"> <b>OTN</b> </div>  | <ul style="list-style-type: none"> <li>• OTN up to OTU4 including mapping of Ethernet, CPRI, Fibre Channel, SDH/SONET client signals, multistage mapping and FEC (Forward Error Correction)</li> <li>• OTN error performance measurement in accordance with G.8201 or M.2401</li> <li>• ITU-T O.182-compliant FEC test</li> <li>• Delay measurement</li> </ul> |
| <div style="background-color: #008080; color: white; padding: 5px; text-align: center; font-size: 8px;"> <b>SDH/SONET</b> </div>  | <ul style="list-style-type: none"> <li>• Powerful testing of SDH (STM-64, STM-16, STM-4, STM-1), SONET (OC-192, OC-48, OC-12, OC-3, STS-3) systems</li> <li>• Analysis of service disruption with APS application</li> <li>• Error-performance test (G.826, G.828, G.829, or M.2100)</li> </ul>  |

The Network Master supports all types of network I&M.

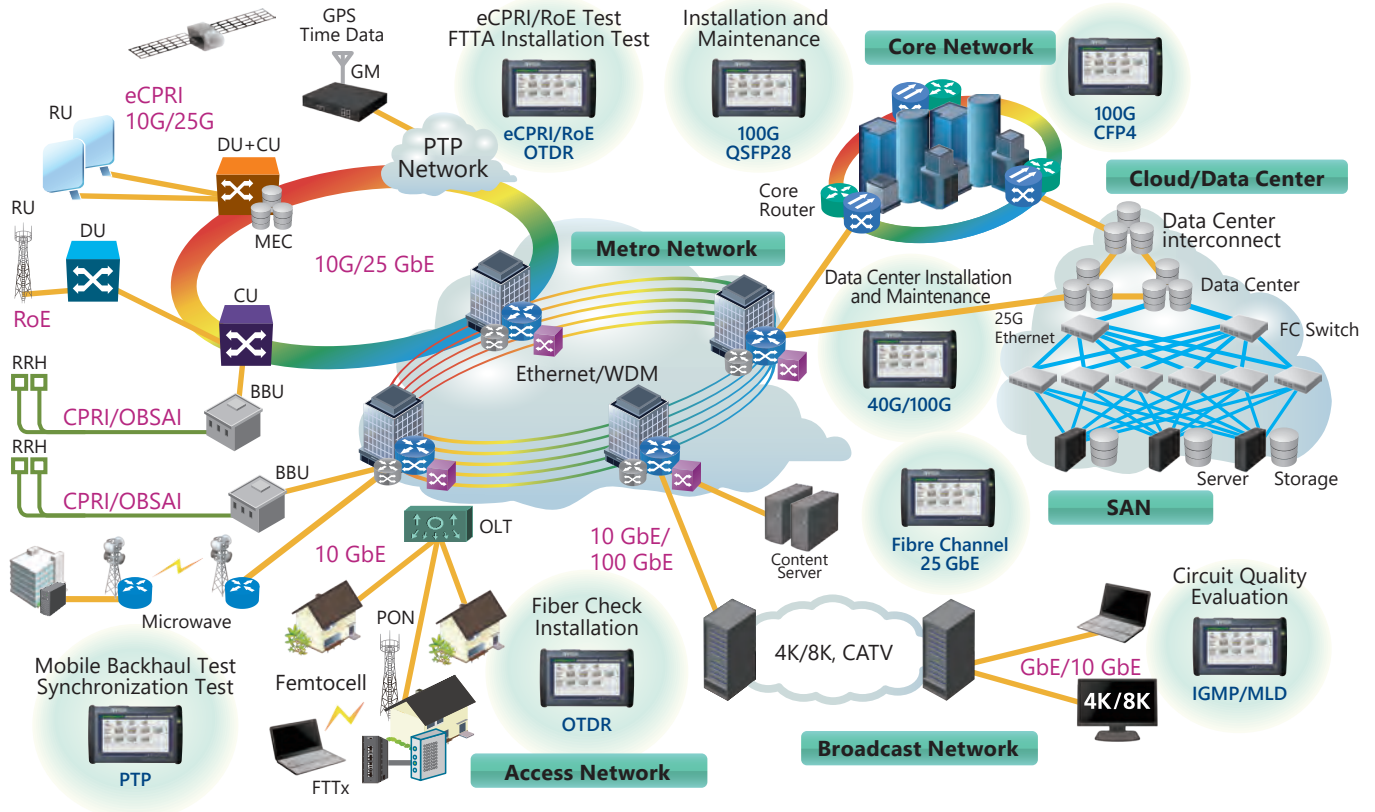

The modular design of the Network Master Pro MT1000A platform makes it easy to support I&M for different network configurations. Combining it with the 10G Multirate Module MU100010A offers the necessary functions for I&M of networks at speeds from 1.5 Mbps to 10 Gbps. Combining with the 100G Multirate Module MU100011A, it supports more interface standards than any other handheld transport tester on the market such as CFP4/QSFP28, QSFP+, SFP28 (25GbE), SFP+SFP and RJ45. Coupled with a compact easy-to-use design and long battery operation, plus a large 9" easy-to-see color touch screen, remote GUI operation via Internet connection, and more, the MT1000A is a key factor in increasing I&M test work efficiency. Furthermore, options for each test function can be selected and added as necessary to match the work schedule, helping cut initial capital costs.

| Interface* | Ethernet     | OTN         | SDH/SONET           | Fibre Channel      | CPRI/OBSAI                                | PDH/DSn      |
|------------|--------------|-------------|---------------------|--------------------|---|--------------|
| CFP4       | 100 GbE      | OTU4        | —                   | —                  | —   | —            |
| QSFP28     | 100 GbE      | OTU4        | —                   | —                  | —   | —            |
| QSFP+      | 40 GbE       | OTU3        | —                   | —                  | —   | —            |
| SFP28      | 25 GbE       | —           | —                   | —                  | CPRI 10                                   | —            |
| SFP/SFP+   | GbE/10 GbE   | OTU1x/OTU2x | STM1-64/<br>OC3-192 | 1G/2G/4G/8G/10G FC | CPRI 1/2/3/4/5/6/7/8<br>OBSAI 1x/2x/4x/8x | —            |
|            |              |             |                     | 16G FC             | CPRI 9                                    |              |
| RJ45       | 10/100/1000M | —           | —                   | —                  | —   | —            |
| RJ48       | —            | —           | —                   | —                  | —   | E1           |
| BNC        | —            | —           | STM-1e/STS-3        | —                  | —   | E1/E3/E4/DS3 |
| Bantam     | —            | —           | —                   | —                  | —   | DS1          |

Legend:   : MU100010A Only      : MU100011A Only      : Both MU100010A & MU100011A Supported

\*: The interface depends on the module. For details, refer to the following.

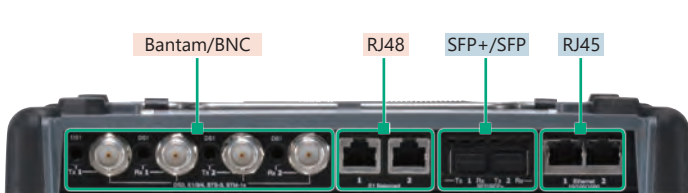

10G Multirate Module MU100010A

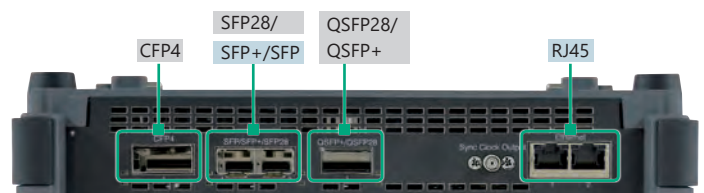

100G Multirate Module MU100011A

As networks get faster, I&M field technicians must not only master the relevant technical knowledge for each network type that includes metro networks, mobile networks, data centers, etc., but must also understand the detailed tester operations for each of these networks. In addition, sometimes multiple items must be measured at each commissioning, increasing the risk of operator errors. But with the versatile and easy-to-use MT1000A functions, the risk of operator errors are decreased.

### Easy-to-Use GUI

The MT1000A GUI (graphical user interface) is designed for intuitive onsite operation and speeds-up I&M test-result evaluations as well as problem troubleshooting. Training time is also cut by the intuitive interface.

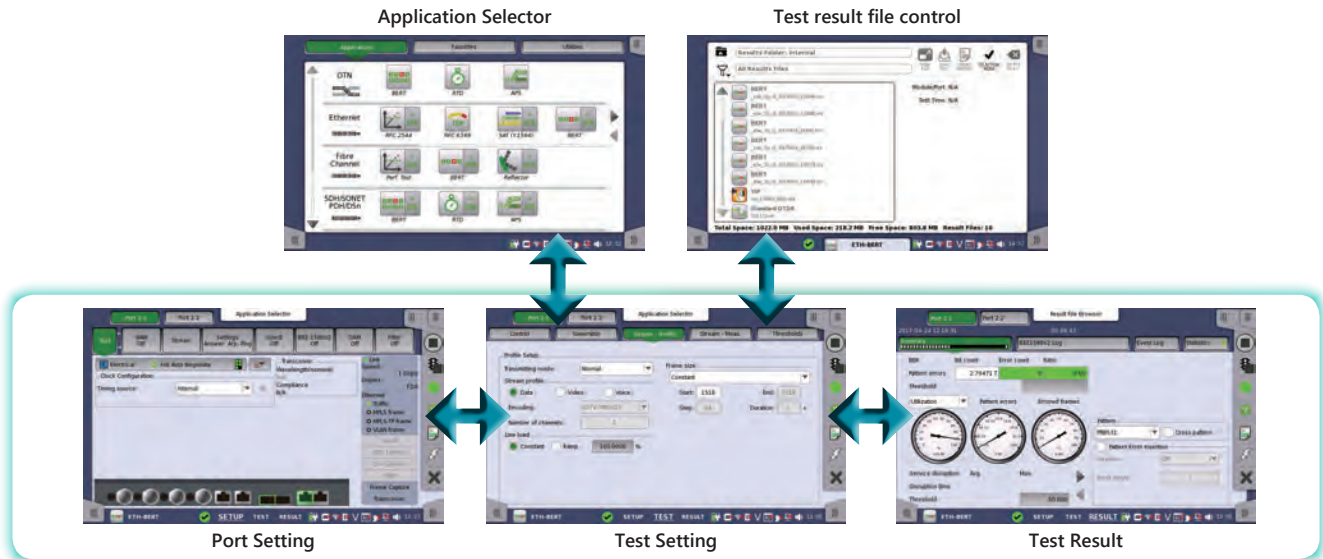

### Remotely Controlled Network Installation, Start-up, and Maintenance

The MT1000A has a useful remote function for network installation, start-up and maintenance. Connecting the office and job site via LAN allows engineers in the office to see screens at the on-site instrument while making settings and measurements, and troubleshooting. This provides an efficient link between engineers and on-site measurements to help cut network installation and maintenance costs.

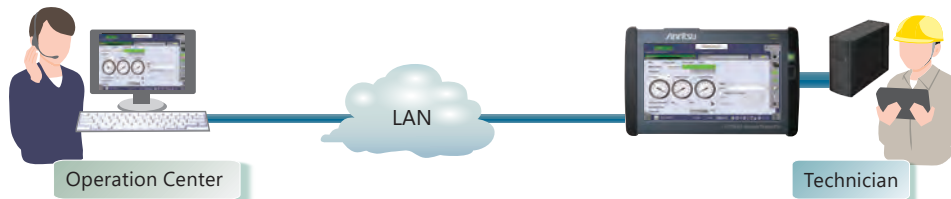

**Easy Connections Anywhere Using SORA (Site Over Remote Access)\***

Using the MX109020A Site Over Remote Access (SORA hereafter) software measuring instruments can be remotely controlled easily anywhere. The SORA cloud-based service allows office users to log-in to an Internet webpage to control the measuring instrument from the office via a smartphone.

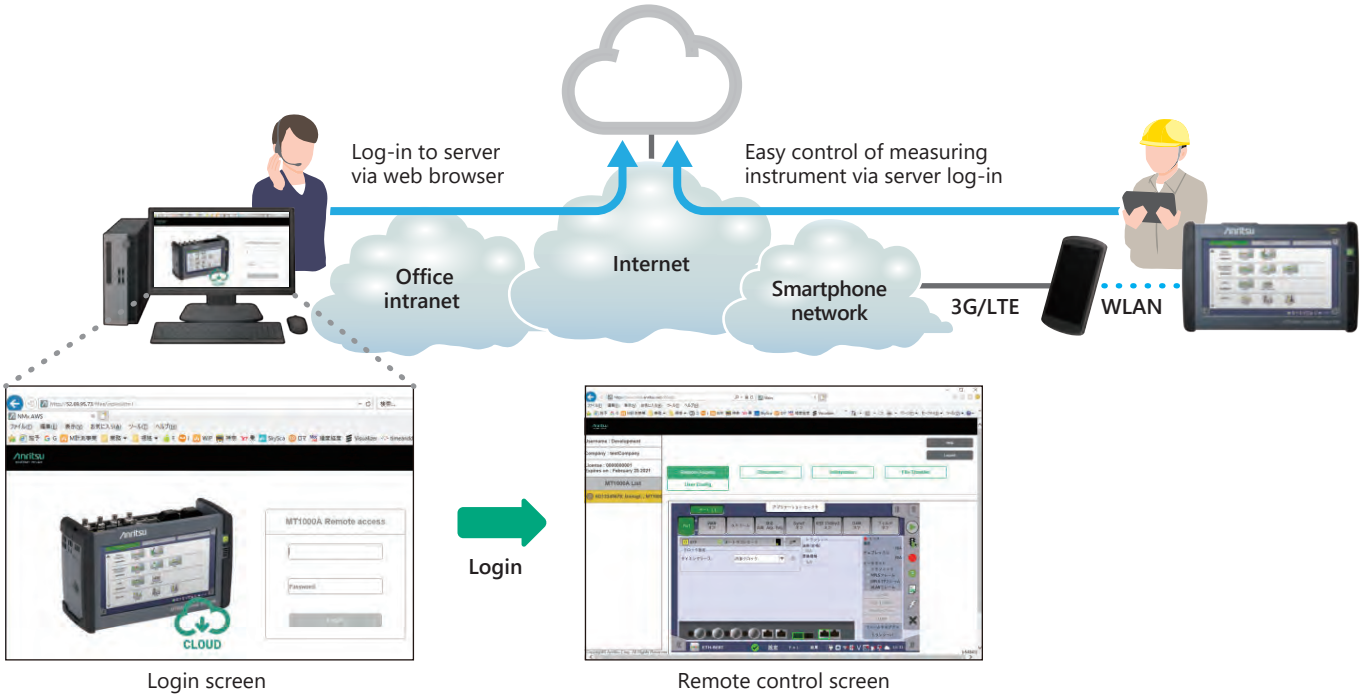

\* This service can be used in countries and regions where the MT1000A WLAN/Bluetooth option has been approved. For details, contact Anritsu.

\* To connect using SORA, you must purchase an option license for the main unit as well as a subscription license. Refer to the MX109020A leaflet and product introduction for more details. You must agree to the service contract before purchasing SORA. Refer to the service contract at the following URL: <https://www.anritsu.com/en-AU/test-measurement/support/downloads/manuals/dwl20059>.

**One Button Testing**

The MT1000A has automatic test functions for simple and efficient network commissioning. These MT1000A automated test functions run scenario files created in advance on a PC to perform tests automatically using preset measurement items, procedures, and pass/fail evaluation conditions. Since the scenario also handles report creation, evaluation and results, inexperienced workers can run accurate tests without operation mistakes and re-tests.

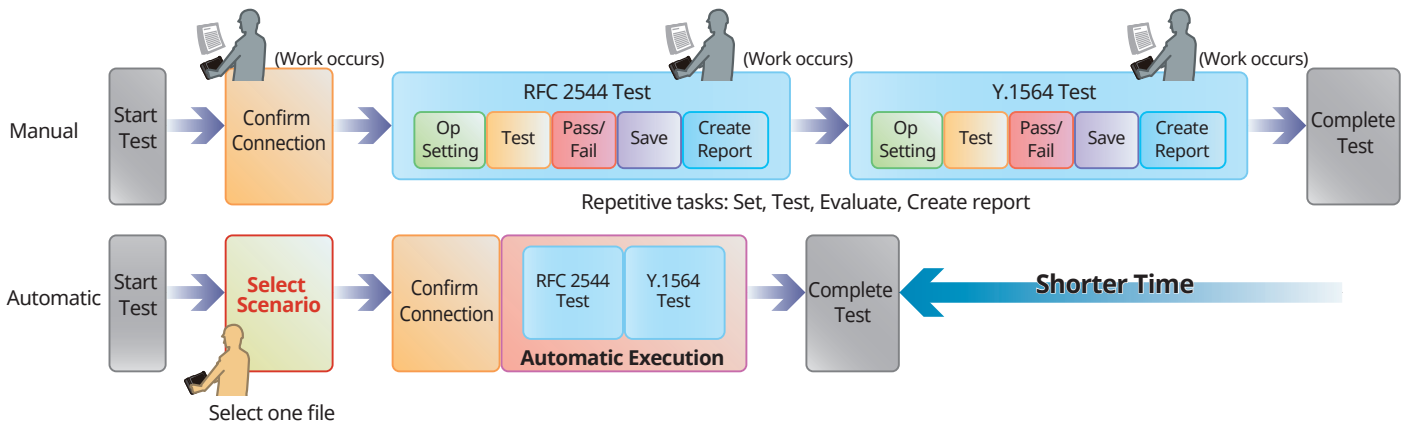
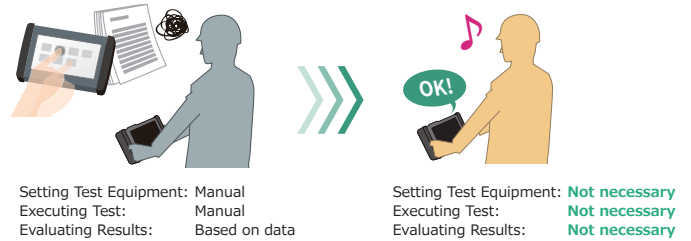

# Ethernet Application

## Carrier Ethernet Installation and Troubleshooting

Network operators are introducing new carrier-class technologies, such as VLAN, Q-in-Q, Ethernet OAM, MPLS, PBB, MPLS-TP, etc., to their Ethernet service menus, increasing test complexity and test time for field technicians. The MU100010A/MU100011A Ethernet test functions provide strong support for commissioning and troubleshooting Ethernet networks up to 100G speeds, including connectivity and band tests, QoS tests, and service-related tests.

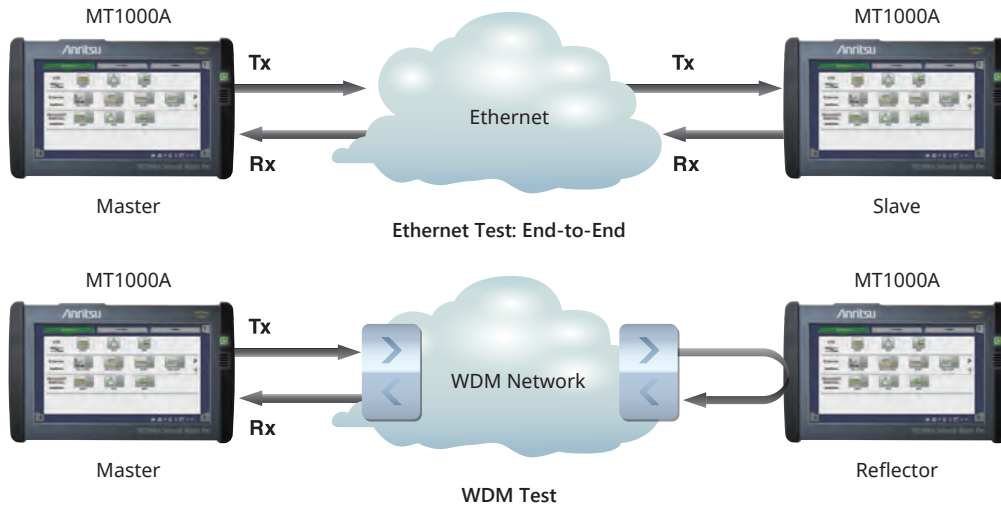

### Ethernet test features include:

- Ethernet tests at 100 Gbps, 40 Gbps, 25 Gbps, 10 Gbps, 1 Gbps, 100 Mbps, and 10 Mbps
- Traffic generation up to full line rate
- Support for IPv4 and IPv6
- Ethernet Service Activation Test (Y.1564)
- Automated RFC 2544 tests of Throughput, Frame Loss, Latency or Packet Jitter, Burstability
- TCP Throughput (RFC 6349, iPerf) [Option]
- BER tests – include Frame Loss and Sequence Error tests
- Service disruption measurements
- Comprehensive statistics
- Filters – to extract relevant parts of traffic
- Thresholds – to highlight abnormalities
- Simultaneous monitoring in both line directions
- IP Channel Statistics to identify error streams, top talkers, network attacks
- Ethernet OAM tests
- 10G WAN-PHY tests
- Synchronous Ethernet test (SyncE), PTP (IEEE 1588 v2)
- IEEE 1588 v2 Phase/Time synchronization test (For optical 1G/10G/25G bps)
- Ethernet Multistream
- Stacked VLAN (Q-in-Q)
- Link Fault Signaling (LFS) Emulation (10G/25G/40G/100G bps)
- IGMP/MLD client function
- MPLS tests
- MPLS-TP and PBB tests
- Ping
- Traceroute
- Frame capture for protocol analysis with Wireshark
- Electrical cable tests and optical signal level displays

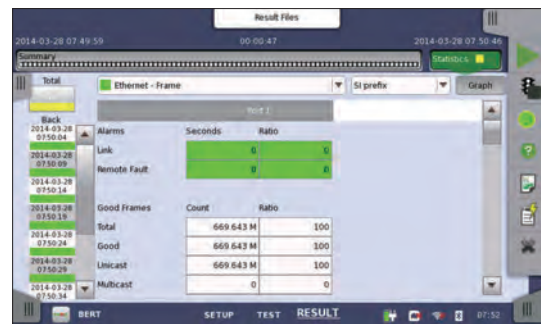

Ethernet Statistics



Ethernet BER Tests Statistics Summary

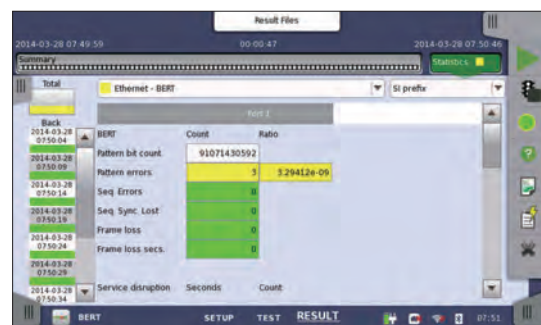

Ethernet BER Tests Results

Wireshark® is a registered trademark of the Wireshark Foundation.

## Carrier Ethernet Installation and Troubleshooting

### Ethernet Service Activation Test (Y.1564)

With the ability to simultaneously test multiple traffic streams, ITU-T Y.1564 is a new test methodology when deploying Ethernet networks. Today's common RFC 2544 standard completes tests one at the time and does not run all traffic streams simultaneously. ITU-T Y.1564 has the following two test phases.

- Service Configuration Test:**

This section is completed quickly, within seconds per stream. It confirms the end-to-end configuration while quickly checking the Information Rate (IR), Frame Transfer Delay (FTD), Frame Delay Variation (FDV), Frame Loss Ratio (FLR), Committed Burst Size (CBS) and Excess Burst Size (EBS) sequentially for all configured traffic streams.

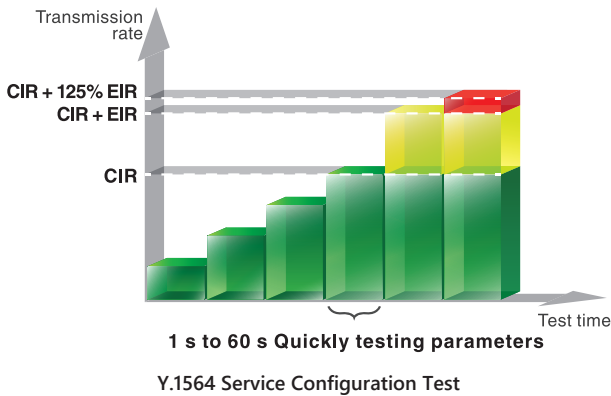

- Service Performance Test:**

This section is completed based on the M.2110 standard for 15 minutes, 2 hours, 24 hours, or a user-selectable period. It transmits all configured traffic streams simultaneously at the CIR, confirming that all traffic can traverse the network under full load while checking IR, FTD, FDV, FLR and Availability (AVAIL).

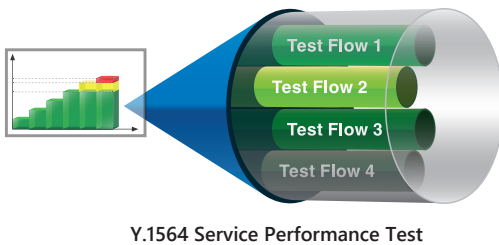

Simultaneous testing in the Service Performance Test section greatly reduces the total test time compared to RFC 2544.

### RFC 2544 Test

RFC 2544 testing of Throughput, Frame Loss, Latency, Packet Jitter and Burstability is straightforward with the MU100010A/MU100011A. It automates the procedure while still allowing thorough test configuration. For full information on performance at both line sides, the end-to-end test mode allows two MT1000A testers to work together in a local-remote configuration where the user controls both testers and reads results from both locally. Easy to understand tabular screens and bar graph presentations simplifies reading of results. Attractive looking reports can be generated for presentation to end-customers.

| Test | Size | # of Flows | Throughput  | RT (ms)     | CPU (%) | Test (Mbps) | Frames lost |
|------|------|------------|-------------|-------------|---------|-------------|-------------|
| 0    | 1    | 64         | 44.642857 M | 14.888952 M | 100.00  | 3095.241552 | 0           |
| 0    | 2    | 64         | 40.178571 M | 13.592857 M | 90.00   | 2785.714464 | 0           |
| 0    | 3    | 64         | 35.714285 M | 11.904761 M | 80.00   | 2476.190944 | 0           |
| 0    | 4    | 64         | 31.250000 M | 10.416666 M | 70.00   | 2166.671520 | 0           |
|      |      |            | 26.785714 M |             | 60.00   |             |             |

Throughput Summary

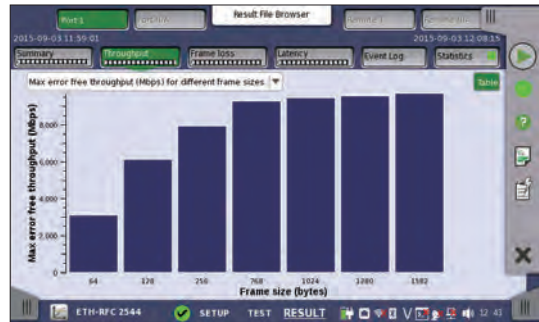

Throughput Graph

### TCP Throughput (RFC 6349, iPerf) [Option]

Normally, IP network operators test their communications equipment in accordance with the RFC 2544 and ITU-T Y.1564 standards, but even when the test results are good, sometimes the expected end-to-end data throughput is not achieved. Although data communications use the TCP protocol for guaranteed data transfers, sometimes throughput drops as a result of network delays, poor circuit quality, etc. The RFC 6349 standard regulates the test methods for assuring operator throughput over the TCP layer, and the MU100010A/MU100011A modules with built-in TCP throughput option support TCP throughput evaluation and testing in accordance with the RFC 6349 standard. The iperf client function for testing TCP throughput is also supported.

| Window size  | Connections | Threshold        | Avg Throughput | Avg RTT  |
|--------------|-------------|------------------|----------------|----------|
| 147696 Bytes | 3           | 95.00 % of Ideal | 9414.924 Mbps  | 0.002 ms |

| Network Parameters | Source     | Value             | RFC6349 Metric      | Result   |
|--------------------|------------|-------------------|---------------------|----------|
| MTU / MSS          | User input | 1500 / 1448 Bytes | Transfer Time Ratio | 1.00     |
| RTT                | User input | 0.125 ms          | TCP Efficiency      | 100.00 % |
| CIR                | User input | 10000.00 Mbps     | Buffer Delay        | -98.48 % |

Test Result



# Ethernet Application

## Carrier Ethernet Installation and Troubleshooting

### Pass-through Mode

Configuring the MU100010A/MU100011A to Pass-through mode supports detailed troubleshooting, especially in bi-directional networks requiring traffic monitoring from both ends.

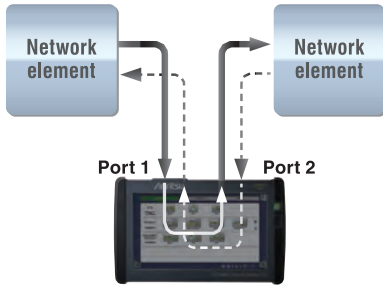

Pass-through monitoring by inserting MT1000A in network

### IP Channel Statistics – Multiflow Counters

Up to 230 flows can be selected and filtered by MAC and IP Source/Destination addresses, VLAN and MPLS to monitor selected streams and display detailed information. This allows the user to identify error streams, top talkers, and network attacks, as well as troubleshoot network issues more deeply.

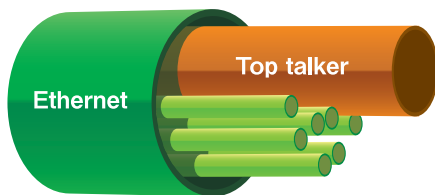

### One-way Delay Measurement Using Two MT1000A Units

One-way delay can be measured with high accuracy using two MT1000A/MU100011A units at a distant location with installed MU100090A.

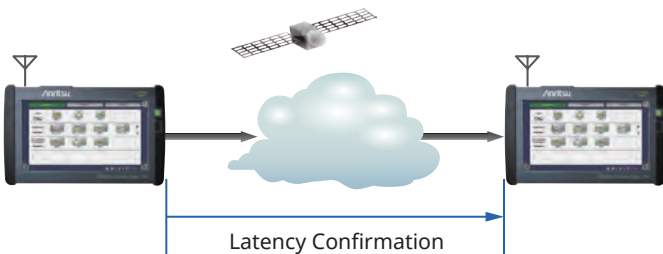

### Ethernet OAM

To improve the performance of Ethernet-based networks and provide Carrier Class service, many network providers have enhanced their systems with Ethernet OAM (Operation, Administration and Maintenance), supporting the ability to detect network faults and measure performance. Ethernet OAM is defined by three standards covering different network sections. The ITU-T Y.1731 and IEEE 802.1ag standards are similar and support end-to-end network functionality, while the IEEE 802.3 (previously IEEE 802.3ah) standard supports first (or last) mile functionality. The MU100010A/MU100011A tests the network using all supported OAM functions.

### Ethernet Multistream

The MU100010A/MU100011A Ethernet Multistream function allows simulation and testing of a congested network's ability to prioritize high-priority traffic over low-priority traffic. The user can set different priorities for up to 16 streams per port to measure how frame loss affects network performance. The Multistream function displays clear information on Packet Jitter and Latency per stream, helping troubleshoot problematic issues for VoIP services, etc.



Multi Stream Setting

### MPLS and MPLS-TP

Multi-Protocol Label Switching (MPLS) supports efficient traffic routing on packet-based networks. MPLS – Transport Profile (MPLS-TP) technology is based on standard MPLS and aims to give service providers reliable connection-oriented packet-based transport over the network. MPLS-TP offers service providers QoS, end-to-end Carrier Class OAM, and protection switching. With its ability to insert up to 8 levels of MPLS labels, the MU100010A/MU100011A is a powerful tool for testing MPLS and MPLS-TP networks including OAM functions.

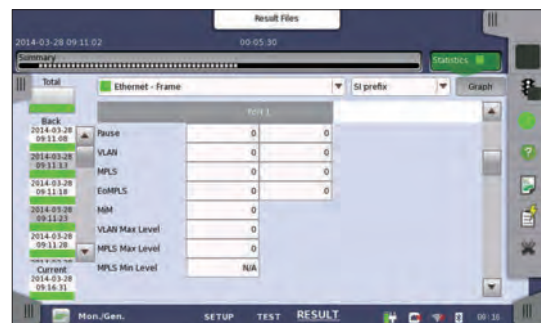

Protocol Counter

# Ethernet Application

## Carrier Ethernet Installation and Troubleshooting

### Stacked VLAN

Stacked VLAN (Q-in-Q) is used increasingly by several types of Ethernet-based networks, allowing operators to split traffic from different customers on one line or to shape traffic by priority. The MU100010A/MU100011A supports up to 8 levels of VLAN tags, offering a powerful network test tool.

### PBB

The Provider Backbone Bridge (PBB) technology is designed to provide Carrier Class division of the networks at layer 2 often referenced as MAC-in-MAC. Allowing multiple provider bridge networks to be interconnected without VLAN addresses conflict.

### Protocol Analysis

For advanced Ethernet troubleshooting the MU100010A/MU100011A supports a frame capture function for capturing frames of live traffic on the monitored line. Captured frames are analyzed using the Wireshark protocol analysis software.

### In-Band Test

Usually at least two field technicians must be dispatched for end-to-end testing, but using the MU100010A/MU100011A in-band measurement function to control the remote MT1000A from the local MT1000A via the test network, cuts the number of required field technicians and increases work efficiency.

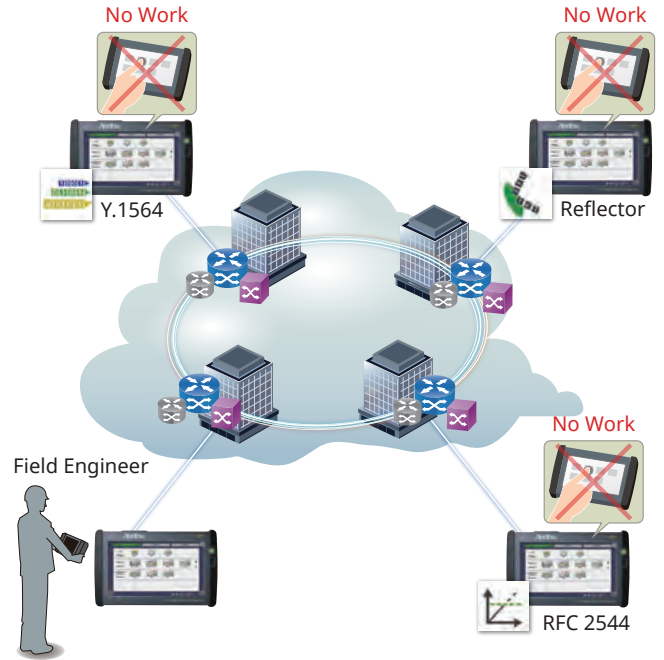

## Broadcast Network Inspection

### Quality Assurance

Ethernet is used for live video at events such as Olympics and concerts and for interactive video at public viewing, etc. Video image quality is degraded by latency and jitter. The MT1000A assures stable network quality using efficient throughput and packet jitter evaluations.

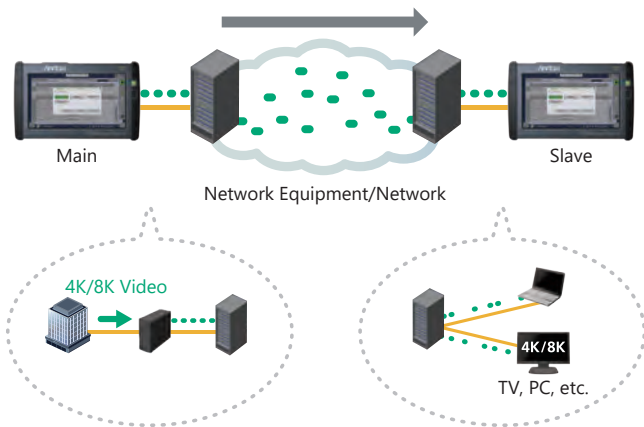

### Multicast Group

Assuring video streaming services requires joining a multicast group. The MT1000A has a IGMP/MLD client function for measurements using multicast packets as well as analysis of actual multicast packets.

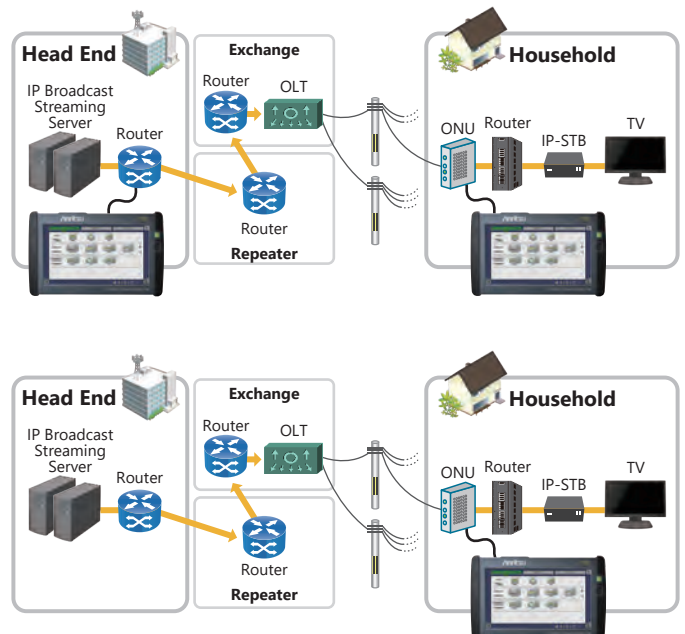

# OTN Application

## Comprehensive OTN Testing for Metro and Core Networks Installation and Maintenance

OTN carries client signals, but current OTN field testers only support OTN testing at the OTN line rate with bulk test signals. This means that problems in the carried client signals are invisible when testing an in-service OTN system.

Using the MU100010A/MU100011A, OTN lines can be tested at the client signal level with signals like Ethernet, CPRI, Fibre Channel and SDH/SONET, because the OTN mapping function is mandatory for modern OTN transponders. The MT1000A can also test OTN lines at the line rate with bulk signals.

The user can identify problems at all levels in the OTN signal, solving OTN issues efficiently, reducing system downtime, and reducing operating expenses for network operators.

### OTN Testing with Client Signals

The MU100010A/MU100011A is a powerful and full toolset for testing OTN signals. It supports complete Bit Error Rate (BER) tests with bulk signals at the OTN level as well as tests all the way to the Ethernet, Fibre Channel and SDH/SONET client signals mapped onto the OTN signal.

### OTN tests features include:

- OTU4, OTU3, OTU3e1, OTU3e2, OTU2, OTU2e, OTU2f, OTU1, OTU1e, OTU1f tests
- Multi Stage Mapping and ODU Flex support
- OTN tests with bulk signals (PRBS, Null or User pattern) at OTN level
- Comprehensive OTN error and alarm statistics
- OTN error performance measurement in accordance with G.8201 or M.2401
- ITU-T O.182-compliant FEC test
- Test of Ethernet, CPRI, Fibre Channel or SDH/SONET client signals mapped onto OTN signal
- Delay measurement
- OTN header edit and capture
- OTN TCM monitoring and generation
- Service disruption analysis using APS application
- OTN tributary scan
- Full flexibility to monitor insert/overwrite client overhead and payload within OTN signal

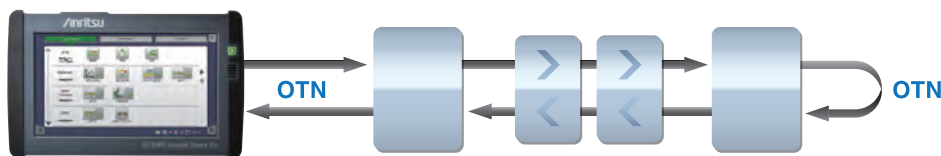

Looping-back test signal from MT1000A at far end supports easy OTN line quality tests

### Out-of-service OTN Error and Alarm Statistics

The MU100010A/MU100011A supports powerful statistical measurements for BER tests as well as OTN level alarms and errors for installing/commissioning and troubleshooting out-of-service OTN lines. G.8201 or M.2401 error-performance parameters are calculated during measurement. Stress testing of network elements is supported by inserting errors and alarms, and adjusting overhead bytes in the signal transmitted by the instrument.

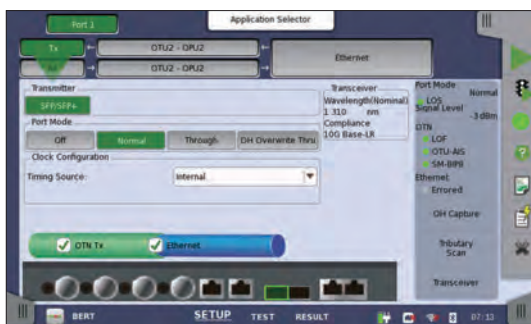

Error/Alarm Setting

### Testing Ethernet, CPRI, Fibre Channel, or SDH/SONET Client Signals Mapped onto OTN Signal (Part of ODU Multiplexing Option)

The MU100010A/MU100011A tests OTN links carrying Ethernet, CPRI, Fibre Channel or SDH/SONET client signals, allowing the operator to test embedded client signals.

For example, an RFC 2544 or Y.1564 test can be performed with an Ethernet signal carried over the OTN signal, allowing the service engineer to run tests emulating the real-world requirements of end users.

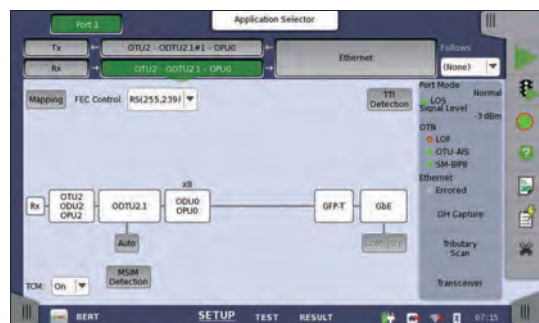

OTN Mapping Setting

## Comprehensive OTN Testing for Metro and Core Networks Installation and Maintenance

### ODUflex Test (with ODU Flex Option)

ODUflex is a new feature of OTN supporting flexible allocation of client-signal bandwidth to make best use of OTN capacity. The MU100010A/MU100011A with ODU Flex option supports ODUflex tests, allowing operators to verify this new technology on their networks.

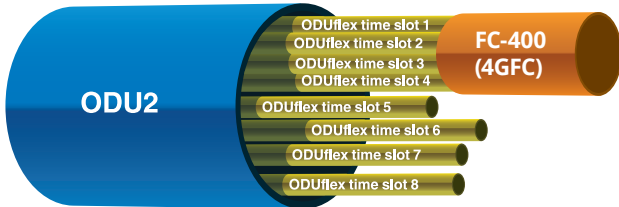

ODU Flex Option divides capacity of ODU2 into eight 1.25G ODUflex time slots. In the above example, an FC-400 (4GFC) Fibre Channel signal occupies four ODUflex time slots.

### ITU-T O.182-compliant FEC Test

Anritsu proposed the FEC performance tests using Poisson-distributed random errors adopted by ITU-T Recommendation O.182. This method supports reproducible and accurate FEC error correction tests by generating truly random signal errors. High-speed networks cannot be tested accurately without using the ITU-T O.182 Poisson error distribution.

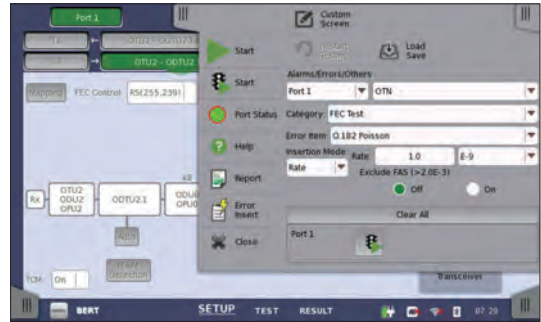

FEC Error Insertion



OTN Statistics Summary

### OTN Tributary Scan

The tributary scan feature supports quick inspection of the OTN signal by examining it for major problems and highlighting them in an easy-to-understand manner.

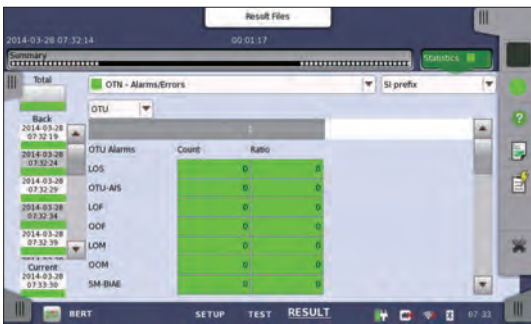

OTU Level Statistics

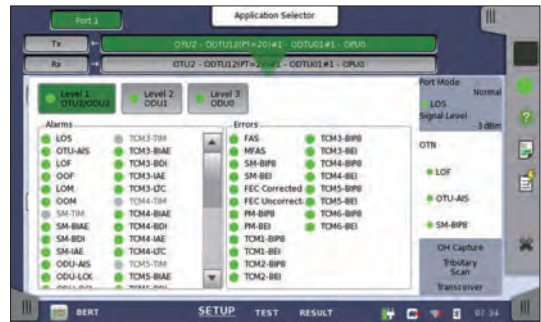

OTU Alarms and Errors View

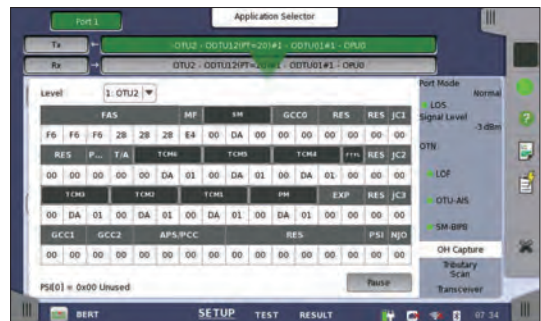

OTU Header Capture

# Mobile xhaul Application

## Tests using Throughput and Protocols

Operators are supporting the explosive spread of smartphones and tablets by increasing the bandwidth of mobile communications networks, in turn driving a complete change in mobile

So far, mobile front haul has been split into the Base Band Unit (BBU) and Remote Radio Head (RRU) with speed increased and ease of connected supported by using multiple antennas.

However, in addition to faster speeds, the key requirements for next-generation 5G mobile are higher reliability, lower latency, and multiple simultaneous user connections. As a result, mobile front haul requires:

- Change of interface between BBU and RRH from CPRI/OBSAI to eCPRI/RoE (IEEE1914.3)
- Improved time synchronization accuracy
- Large decreases in latency.

### eCPRI/RoE (IEEE1914.3) Test

- BER tests using either eCPRI or RoE frame
- One and two-way latency time measurements\*1
- Phase/Time synchronization accuracy tests
  - Time synchronization test using IEEE 1588 v2 1 pps TE supporting 1G/10G/25G Ethernet

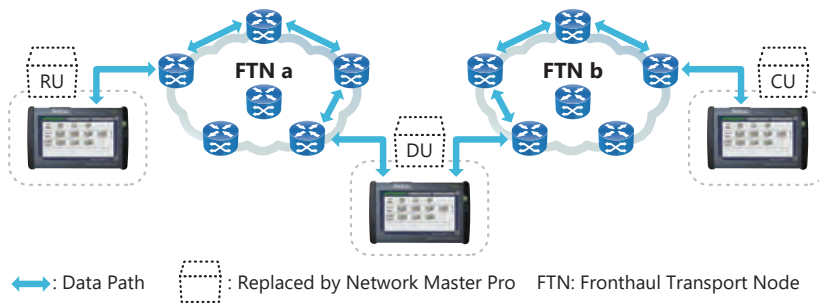

### CPRI Test

- BER tests
- Various error and alarm tests
- Return Time Delay (RTD) tests
- Perform pass-through monitoring\*2 and CPRI APS measurements
- Client signal mapped to OTN.

### OBSAI Test

- BER tests
- Various error and alarms tests
- Return Time Delay (RTD)
- Perform OBSAI APS measurements

\*1: Requires MU100011A for high-resolution measurement; requires two MT1000A/MU100011A/MU100090A units for measurement at distant location

\*2: CPRI Option 9 and Option 10 not supported

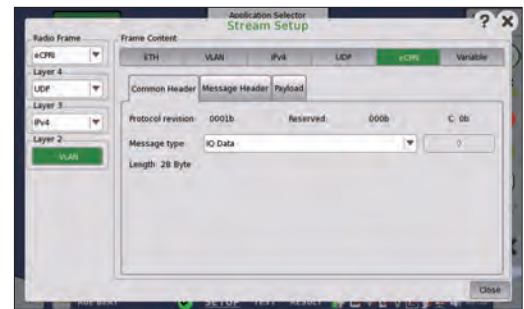
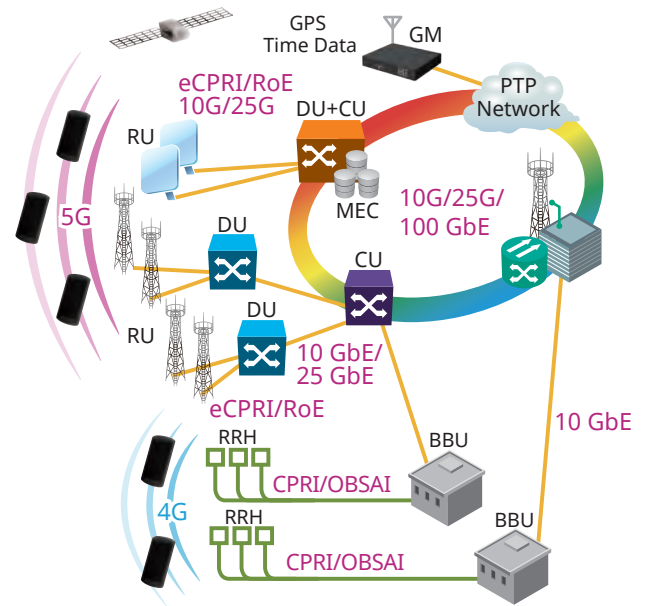

eCPRI Frame Setting

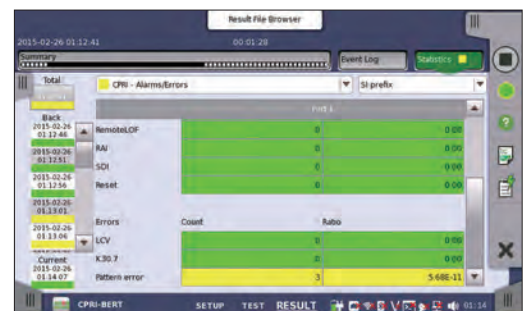

CPRI/OBSAI BER Test



CPRI Link Status

# Mobile xhaul Application

## Time Synchronization, Phase Evaluation

Mobile backhaul networks use IEEE 1588 v2 and synchronous Ethernet (SyncE) technologies. Since in-office base stations generate wireless signals based on a synchronizing signal distributed by the mobile backhaul, any mobile backhaul synchronization fault severely degrades the mobile radio performance. As a result, mobile operators must test that the SyncE and IEEE 1588 v2 technologies are functioning correctly.

### Synchronous Ethernet test

The MU100010A/MU100011A support SyncE and IEEE 1588 v2 (G.8265.1, G.8275.1 and G.8275.2) protocol tests and analyses for monitoring SSM messages, and effectively troubleshooting and analyzing network faults, such as interoperability issues caused by abnormal vendor clock devices.

### Time/Phase Synchronization Accuracy Tests

Mobile backhaul is starting construction of IEEE 1588 v2 (G.8275.1)-compliant time and phase-synchronized networks.

The High Performance GPS Disciplined Oscillator MU100090A option measures the time and phase synchronization with high accuracy as a  $\max|TE|$  (absolute Time Error), cTE (Constant Time Error), and dTE (Dynamic Time Error) matrix.\*

Combining it with the MU100010A/MU100011A adds pass/fail evaluation tests for commissioning time and phase-synchronized networks.

\*: Peer-to-Peer only supports protocol emulation.

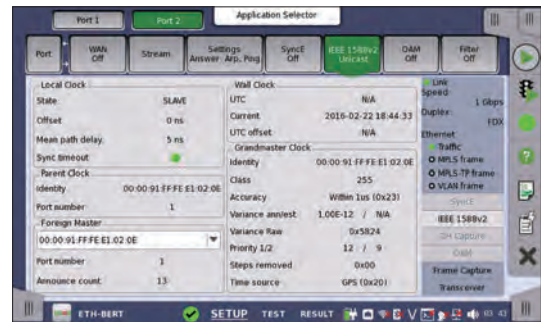
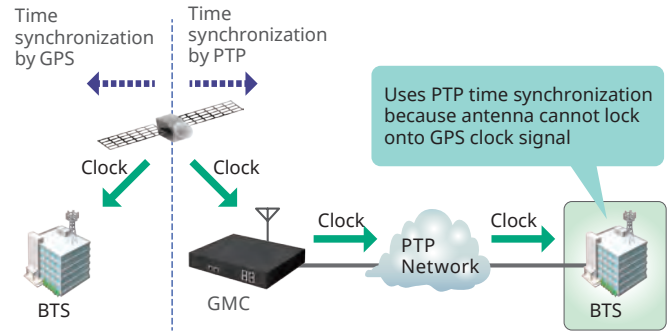

Status of IEEE 1588 v2 Slave Clock

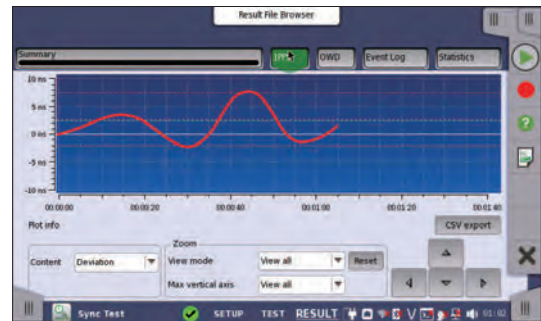

Phase Confirmation using MU100090A

# Fibre Channel Application

## Powerful Storage Area Networking (SAN) Testing

Many operators need to support Fibre Channel links in Storage Area Networks (SAN) together with other transport technologies like OTN, Ethernet, and SDH/SONET. Having one tool for all technologies is important for efficient testing. The multi-protocol MU100010A/MU100011A with Fibre Channel option is the perfect tool for deploying Fibre Channel with support for testing links at rates up to 10 Gbps and it also supports other technologies like OTN, Ethernet, CPRI/OBSAI, SDH/SONET and PDH/DSn. The all-in-one MT1000A gives the user less equipment to maintain and learn, helping reduce operating expenses.

### Fibre Channel test features include:

- 1GFC, 2GFC, 4GFC, 8GFC, 10GFC, and 16GFC tests
- Latency measurement
- BER tests including service disruption measurement
- Line alarm and error monitor
- Normal or Reflector mode
- Performance Test
- Buffer Credit environment
- Optional mapping to OTN

### Latency

High latency is a problem for many applications, including SAN, and network operators and service providers urgently need a tool like the MU100010A/MU100011A with Fibre Channel option to test latency on Fibre Channel lines and equipment.

### Fibre Channel BER Tests

The MU100010A/MU100011A with Fibre Channel option supports BER tests to measure the performance of Fibre Channel lines and equipment. Service disruption measurement is also supported.

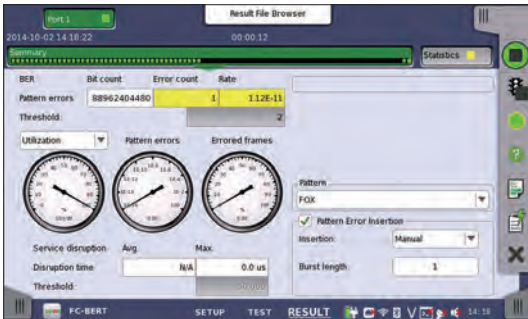

FC BER Test

### Performance Tests

Fibre Channel achieves frame-loss-free transmissions using buffer-credit-based flow control. On the other hand, throughput rates drop due to the wasted wait times if the buffer size is small compared to the network transmission delay time.

The MU100010A/MU100011A measures the buffer size needed to achieve the required throughput and can play a key role in the following aspects of network I&M.

- Adjusting local parameters at commissioning testing
- Troubleshooting whether buffer size setting or network settings are causing lower throughput than the network design specification

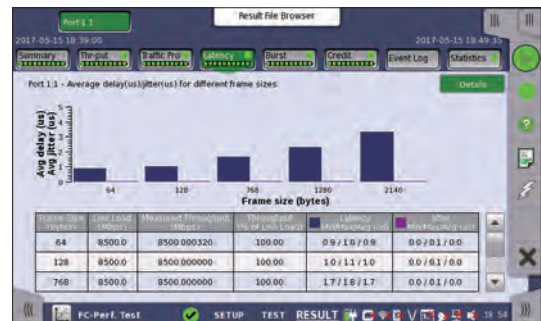

FC Performance Test

### Flow Control

#### Credit-based Flow Control

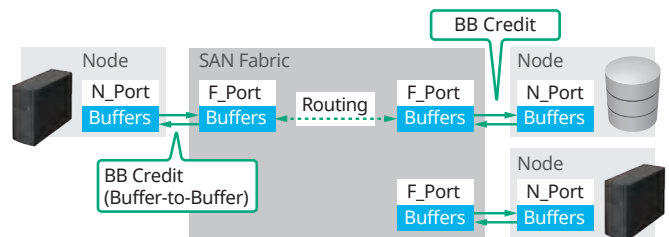

#### BB Credit

Flow control between physically connected ports. Used for propagation of data of all classes.

# SDH/SONET, PDH/DSn Application

## Quick and Easy Tests of SDH/SONET and PDH/DSn Networks

Legacy technologies in transport networks can't just be eliminated because of the huge capital investment, but keeping legacy technologies operational can require several testers.

With its SDH/SONET and PDH/DSn test options, the MU100010A/MU100011A is a powerful and easy-to-use tool for testing SDH/SONET up to STM-64/OC-192. PDH/DSn systems (E1, E3, E4, DS1 and DS3) can be tested directly or embedded into SDH/SONET. The MT1000A can support new and legacy technologies, leaving the user less equipment to maintain and learn, and reducing operating expenses.

### SDH/SONET and PDH/DSn test features include:

- Powerful testing of SDH (STM-64, STM-16, STM-4, STM-1), SONET (OC-192, OC-48, OC-12, OC-3, STS-3) systems and embedded PDH (E1, E3, E4) and DSn (DS1, DS3) systems
- Powerful testing of PDH (E1, E3, E4) and DSn (DS1, DS3) systems
- Simultaneous bi-directional monitoring of SDH/SONET and PDH/DSn lines
- SDH/SONET mapping and de-mapping of PDH/DSn signals
- Comprehensive error and alarm statistics
- SDH/SONET overhead byte testing and monitoring
- SDH/SONET tributary scan
- SDH/SONET pointer event generation and monitoring
- SDH/SONET and PDH/DSn delay measurements
- Analysis of service disruption with APS application

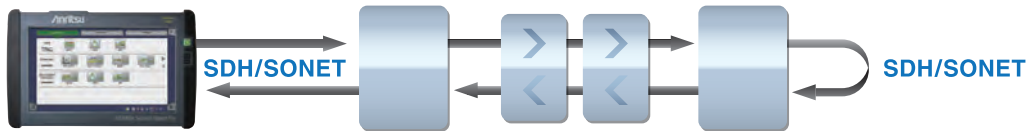

Looping-back test signal from MT1000A at far end supports SDH/SONET line quality tests

### SDH/SONET Installing and Commissioning Testing

The MU100010A/MU100011A has powerful statistical measurements for BER testing at installing/commissioning and troubleshooting out-of-service SDH/SONET lines. Statistics are also collected for in-service analysis of line transmission-error performance together with information on pointer operations. G.826, G.828, G.829, or M.2100 error-performance parameters are calculated and the measurement result is highlighted by easy-to-understand color coding. Errors, alarms, pointer operations and overhead byte changes can be inserted into the transmitted signal for stress testing.

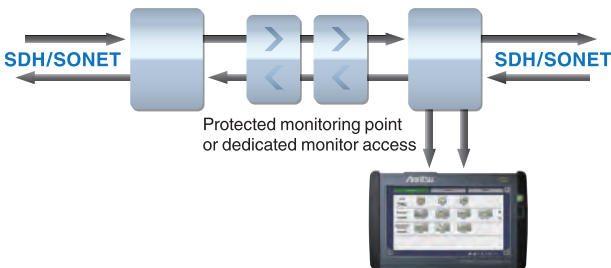

Bi-directional in-service monitoring of SDH/SONET lines



Quick overview of errors and alarms for both sides of SDH/SONET line

### Speeds-up SDH/SONET Troubleshooting

The MU100010A/MU100011A monitor function speeds-up troubleshooting by providing key information on the monitored system, including line alarms and errors, input frequency and deviation, optical input level and overhead bytes. Information is also available on embedded PDH/DSn signals.

### PDH (E1, E3, E4) and DSn (DS1, DS3) Testing

The MU100010A/MU100011A has powerful statistical measurements for BER testing at installing/commissioning and troubleshooting out-of-service PDH/DSn lines. Statistics are also collected for in-service analysis of line transmission-error performance of PDH/DSn lines, and G.826 or M.2100 error-performance parameters are calculated. Furthermore, PDH/DSn signals can be mapped to the SDH/SONET signal.

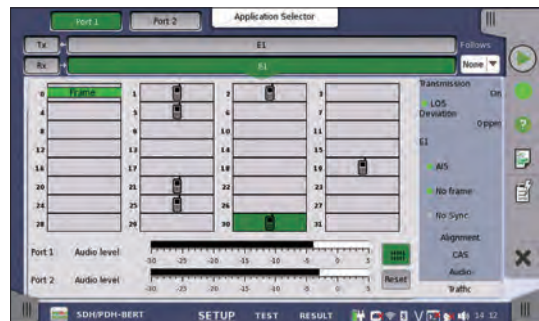

Monitor 64 kbps traffic channels on bidirectional E1 line with MU100010A/MU100011A traffic display



# Optical Modules Selection Guide

| Model/Order No.                             | Description (Approx. Distance)                       | Max. Input Power    | Input Sensitivity    | Input Wavelength   | Output Power  | Output Wavelength  | Loop Back  |
|---|--|---------------------|----------------------|--|---|--|------------|
| G0332A<br>100M FX 1310 nm MM SFP            | 100BASE - FX 1310 nm multi mode (2 km)               | -14 dBm             | -31 dBm              | 1270 nm to 1600 nm   | -20 to -15 dBm  | 1280 nm to 1380 nm   | OK         |
| G0319A<br>Up to 2.7G 1310 nm 15 km SFP      | STM-1/4/16 short haul 1310 nm single mode (15 km)    | 0 dBm               | -18 dBm              | 1270 nm to 1580 nm   | -5 to 0 dBm   | 1260 nm to 1360 nm   | OK         |
| G0320A<br>Up to 2.7G 1310 nm 40 km SFP      | STM-1/4/16 long haul 1310 nm single mode (40 km)     | -9 dBm              | -27 dBm              | 1270 nm to 1580 nm   | -2 to +3 dBm  | 1280 nm to 1335 nm   | >12 dB ATT |
| G0321A<br>Up to 2.7G 1550 nm 80 km SFP      | STM-1/4/16 long haul 1550 nm single mode (80 km)     | -9 dBm              | -28 dBm              | 1270 nm to 1580 nm   | -2 to +3 dBm  | 1500 nm to 1580 nm   | >12 dB ATT |
| G0328A<br>1G/2G/4G FC 850 nm SFP            | 1GFC, 2GFC, 4GFC 850 nm multi mode (0.5 km)          | -3 dBm              | -15 dBm              | 830 nm to 860 nm   | -9 to 0 dBm   | 830 nm to 860 nm   | >3 dB ATT  |
| G0322A<br>1G/2G/4G FC 1310 nm SFP           | 1GFC, 2GFC, 4GFC 1310 nm single mode (10 km)         | -3 dBm              | -18 dBm              | 1260 nm to 1360 nm   | -8 to 0 dBm   | 1260 nm to 1360 nm   | >3 dB ATT  |
| G0323A<br>1G/2G/4G FC 1550 nm SFP           | 1GFC, 2GFC, 4GFC 1550 nm single mode (40 km)         | -3 dBm              | -18 dBm              | 1470 nm to 1600 nm   | 0 to +5 dBm   | 1510 nm to 1590 nm   | >8 dB ATT  |
| G0315A<br>10G LR/LW 1310 nm SFP+            | 10GBASE - LR 1310 nm single mode (10 km)             | +0.5 dBm            | -14.4 dBm            | 1260 nm to 1565 nm   | -6 to -1 dBm  | 1290 nm to 1330 nm   | OK         |
| G0316A<br>10G ER/EW 1550 nm 40 km SFP+      | 10GBASE - ER 1550 nm single mode (40 km)             | -1 dBm              | -15.8 dBm            | 1260 nm to 1565 nm   | -3 to +3 dBm  | 1530 nm to 1560 nm   | >4 dB ATT  |
| G0318A<br>10G ZR/ZW 1550 nm 80 km SFP+      | 10GBASE - ER 1550 nm single mode (80 km)             | -8 dBm              | -22 dBm              | 1260 nm to 1565 nm   | 0 to +5 dBm   | 1525 nm to 1565 nm   | >13 dB ATT |
| G0329A<br>10G LR 1310 nm SFP+               | 10GBASE - LR 1310 nm single mode (10 km)             | +0.5 dBm            | -14 dBm              | 1260 nm to 1355 nm   | -8.2 to +0.5 dBm  | 1260 nm to 1355 nm   | OK         |
| G0356A<br>8G FC/10G SR 850 nm SFP+          | 8GFC, 10GFC, 10GBASE - SR 850 nm multi mode (0.3 km) | -1 dBm              | -11.1 dBm            | 840 nm to 860 nm   | -7.3 to -1 dBm  | 840 nm to 860 nm   | OK         |
| G0386A<br>16GFC SR 850 nm SFP+              | 16GFC 850 nm multi mode (0.035 km)                   | 0 dBm               | -10.5 dBm            | 840 nm to 860 nm   | -7.5 dBm ~  | 840 nm to 860 nm   | OK         |
| G0387A<br>16GFC LR 1310 nm SFP+             | 16GFC 1310 nm single mode (10 km)                    | +2 dBm              | -12 dBm              | 1295 nm to 1325 nm   | -5 to +2 dBm  | 1295 nm to 1325 nm   | OK         |
| G0388A<br>25G SR 850 nm QSFP28              | 25GBASE - SR 850 nm multi mode (0.1 km)              | +2.4 dBm            | -10.3 dBm            | 840 nm to 860 nm   | -8.4 to +2.4 dBm  | 840 nm to 860 nm   | OK         |
| G0389A<br>25G LR 1310 nm QSFP28             | 25GBASE - LR 1310 nm single mode (10 km)             | +2 dBm              | -13.3 dBm            | 1260 nm to 1350 nm   | -7 to +2 dBm  | 1295 nm to 1325 nm   | OK         |
| G0359A<br>40G SR4 850 nm QSFP+              | 40GBASE - SR4 850 nm multi mode (0.1 km)             | +2.4 dBm (per Lane) | -9.9 dBm             | 840 nm to 860 nm   | -8 to +2.4 dBm  | 840 nm to 860 nm   | OK         |
| G0334A<br>40G LR4 1310nm QSFP+              | 40G Ethernet/OTN 1310 nm single mode (10 km)         | +2.3 dBm (per Lane) | -11.5 dBm (per Lane) | 1264.5 nm to 1277.5 nm<br>1284.5 nm to 1297.5 nm<br>1304.5 nm to 1317.5 nm<br>1324.5 nm to 1337.5 nm         | +8.3 dBm (max.) (Total)<br>-2 to +2.3 dBm (per Lane)    | 1264.5 nm to 1277.5 nm<br>1284.5 nm to 1297.5 nm<br>1304.5 nm to 1317.5 nm<br>1324.5 nm to 1337.5 nm         | OK         |
| G0366A<br>100G SR4 850 nm QSFP28            | 100G Ethernet 850 nm multi mode (0.1 km)             | +2.4 dBm (per Lane) | -9.9 dBm (per Lane)  | 840 nm to 860 nm   | +8.9 dBm (max.) (Total)<br>-9.1 to +2.4 dBm (per Lane)  | 840 nm to 860 nm   | OK         |
| G0364A<br>100G LR4 1310 nm QSFP28           | 100G Ethernet 1310 nm single mode (10 km)            | +4.5 dBm (per Lane) | -8.6 dBm (per Lane)  | 1294.53 nm to 1296.59 nm<br>1299.02 nm to 1301.09 nm<br>1303.54 nm to 1305.63 nm<br>1308.09 nm to 1310.19 nm | +10.5 dBm (max.) (Total)<br>-4.3 to +4.5 dBm (per Lane) | 1294.53 nm to 1296.59 nm<br>1299.02 nm to 1301.09 nm<br>1303.54 nm to 1305.63 nm<br>1308.09 nm to 1310.19 nm | OK         |
| G0365A<br>100G LR4 Dual Rate 1310 nm QSFP28 | 100G Ethernet /OTN 1310 nm single mode (10 km)       | +4 dBm (per Lane)   | -8.4 dBm (per Lane)  | 1294.53 nm to 1296.59 nm<br>1299.02 nm to 1301.09 nm<br>1303.54 nm to 1305.63 nm<br>1308.09 nm to 1310.19 nm | +10 dBm (max.) (Total)<br>-0.6 to +4 dBm (per Lane)     | 1294.53 nm to 1296.59 nm<br>1299.02 nm to 1301.09 nm<br>1303.54 nm to 1305.63 nm<br>1308.09 nm to 1310.19 nm | OK         |
| G0369A<br>100G LR4 Dual Rate 1310 nm CFP4   | 100G Ethernet /OTN 1310 nm single mode (10 km)       | +4.5 dBm (per Lane) | -8.6 dBm (per Lane)  | 1294.53 nm to 1296.59 nm<br>1299.02 nm to 1301.09 nm<br>1303.54 nm to 1305.63 nm<br>1308.09 nm to 1310.19 nm | +10.5 dBm (max.) (Total)<br>-4.3 to +4.5 dBm (per Lane) | 1294.53 nm to 1296.59 nm<br>1299.02 nm to 1301.09 nm<br>1303.54 nm to 1305.63 nm<br>1308.09 nm to 1310.19 nm | OK         |

# Optical Modules Selection Guide

| MUJ10010A | Model/<br>Order No. | Name                              | Form<br>Factor | 100 Meg Ethernet  | 156 Meg STM-1      | 614 Meg CPRI | 622 Meg STM-4 | 768 Meg OBSAI | 1GFC               | 1.23 Gig CPRI | 1.25 Gig Ethernet | 1.54 Gig OBSAI | 2GFC | 2.46 Gig CPRI | 2.488 Gig STM-16 | 2.67 Gig OTU1 | 3.07 Gig CPRI OBSAI | 4GFC | 4.92 Gig CPRI | 6.14 Gig CPRI OBSAI | 8GFC               | 9.83 Gig CPRI | 9.95 Gig STM-64 | 10.1 Gig CPRI | 10.3 Gig Ethernet | 10GFC | 10.7 Gig OTU2 | 11.05 Gig OTU1e | 11.09 Gig OTU2e | 11.27 Gig OTU1f | 11.3 Gig OTU2f | 16GFC | 25G Ethernet | 40G Ethernet | 40G OTN | 100G Ethernet | 100G OTN |  |  |  |  |
|-----------|---------------------|-----------------------------------|----------------|-------------------|--------------------|--------------|---------------|---------------|--------------------|---------------|-------------------|----------------|------|---------------|------------------|---------------|---------------------|------|---------------|---------------------|--------------------|---------------|-----------------|---------------|-------------------|-------|---------------|-----------------|-----------------|-----------------|----------------|-------|--------------|--------------|---------|---------------|----------|--|--|--|--|
| ✓         | G0332A              | 100M FX 1310 nm MM SFP            | SFP            | 1310 nm, MM, 2 km |                    |              |               |               |                    |               |                   |                |      |               |                  |               |                     |      |               |                     |                    |               |                 |               |                   |       |               |                 |                 |                 |                |       |              |              |         |               |          |  |  |  |  |
| ✓         | G0319A              | Up to 2.7G 1310 nm 15 km SFP      | SFP            |                   | 1310 nm, SM, 15 km |              |               |               |                    |               |                   |                |      |               |                  |               |                     |      |               |                     |                    |               |                 |               |                   |       |               |                 |                 |                 |                |       |              |              |         |               |          |  |  |  |  |
| ✓         | G0320A              | Up to 2.7G 1310 nm 40 km SFP      | SFP            |                   | 1310 nm, SM, 40 km |              |               |               |                    |               |                   |                |      |               |                  |               |                     |      |               |                     |                    |               |                 |               |                   |       |               |                 |                 |                 |                |       |              |              |         |               |          |  |  |  |  |
| ✓         | G0321A              | Up to 2.7G 1550 nm 80 km SFP      | SFP            |                   | 1550 nm, SM, 80 km |              |               |               |                    |               |                   |                |      |               |                  |               |                     |      |               |                     |                    |               |                 |               |                   |       |               |                 |                 |                 |                |       |              |              |         |               |          |  |  |  |  |
| ✓         | G0328A              | 1G/2G/4G FC 850 nm SFP            | SFP            |                   |                    |              |               |               | 850 nm, MM, 0.5 km |               |                   |                |      |               |                  |               |                     |      |               |                     |                    |               |                 |               |                   |       |               |                 |                 |                 |                |       |              |              |         |               |          |  |  |  |  |
| ✓         | G0322A              | 1G/2G/4G FC 1310 nm SFP           | SFP            |                   |                    |              |               |               | 1310 nm, SM, 10 km |               |                   |                |      |               |                  |               |                     |      |               |                     |                    |               |                 |               |                   |       |               |                 |                 |                 |                |       |              |              |         |               |          |  |  |  |  |
| ✓         | G0323A              | 1G/2G/4G FC 1550 nm SFP           | SFP            |                   |                    |              |               |               | 1550 nm, SM, 40 km |               |                   |                |      |               |                  |               |                     |      |               |                     |                    |               |                 |               |                   |       |               |                 |                 |                 |                |       |              |              |         |               |          |  |  |  |  |
| ✓         | G0315A              | 10G LR/LW 1310 nm SFP+            | SFP+           |                   |                    |              |               |               |                    |               |                   |                |      |               |                  |               |                     |      |               |                     | 1310 nm, SM, 10 km |               |                 |               |                   |       |               |                 |                 |                 |                |       |              |              |         |               |          |  |  |  |  |
| ✓         | G0316A              | 10G ER/EW 1550 nm 40 km SFP+      | SFP+           |                   |                    |              |               |               |                    |               |                   |                |      |               |                  |               |                     |      |               |                     | 1550 nm, SM, 40 km |               |                 |               |                   |       |               |                 |                 |                 |                |       |              |              |         |               |          |  |  |  |  |
| ✓         | G0318A              | 10G ZR/ZW 1550 nm 80 km SFP+      | SFP+           |                   |                    |              |               |               |                    |               |                   |                |      |               |                  |               |                     |      |               |                     | 1550 nm, SM, 80 km |               |                 |               |                   |       |               |                 |                 |                 |                |       |              |              |         |               |          |  |  |  |  |
| ✓         | G0329A              | 10G LR 1310 nm SFP+               | SFP+           |                   |                    |              |               |               | 1310 nm, SM, 10 km |               |                   |                |      |               |                  |               |                     |      |               |                     |                    |               |                 |               |                   |       |               |                 |                 |                 |                |       |              |              |         |               |          |  |  |  |  |
| ✓         | G0356A              | 8G FC/10G SR 850 nm SFP+          | SFP+           |                   |                    |              |               |               |                    |               |                   |                |      |               |                  |               |                     |      |               |                     | 850 nm, MM, 0.3 km |               |                 |               |                   |       |               |                 |                 |                 |                |       |              |              |         |               |          |  |  |  |  |
| ✓         | G0386A              | 16GFC SR 850 nm SFP+              | SFP+           |                   |                    |              |               |               |                    |               |                   |                |      |               |                  |               |                     |      |               |                     |                    |               |                 |               |                   |       |               |                 |                 |                 |                |       |              |              |         |               |          |  |  |  |  |
| ✓         | G0387A              | 16GFC LR 1310 nm SFP+             | SFP+           |                   |                    |              |               |               |                    |               |                   |                |      |               |                  |               |                     |      |               |                     |                    |               |                 |               |                   |       |               |                 |                 |                 |                |       |              |              |         |               |          |  |  |  |  |
| ✓         | G0388A              | 25G SR 850 nm SFP28               | SFP28          |                   |                    |              |               |               |                    |               |                   |                |      |               |                  |               |                     |      |               |                     |                    |               |                 |               |                   |       |               |                 |                 |                 |                |       |              |              |         |               |          |  |  |  |  |
| ✓         | G0389A              | 25G LR 1310 nm SFP28              | SFP28          |                   |                    |              |               |               |                    |               |                   |                |      |               |                  |               |                     |      |               |                     |                    |               |                 |               |                   |       |               |                 |                 |                 |                |       |              |              |         |               |          |  |  |  |  |
| ✓         | G0359A              | 40G SR4 850 nm QSFP+              | QSFP+          |                   |                    |              |               |               |                    |               |                   |                |      |               |                  |               |                     |      |               |                     |                    |               |                 |               |                   |       |               |                 |                 |                 |                |       |              |              |         |               |          |  |  |  |  |
| ✓         | G0334A              | 40G LR4 1310 nm QSFP+             | QSFP+          |                   |                    |              |               |               |                    |               |                   |                |      |               |                  |               |                     |      |               |                     |                    |               |                 |               |                   |       |               |                 |                 |                 |                |       |              |              |         |               |          |  |  |  |  |
| ✓         | G0366A              | 100G SR4 850 nm QSFP28            | QSFP28         |                   |                    |              |               |               |                    |               |                   |                |      |               |                  |               |                     |      |               |                     |                    |               |                 |               |                   |       |               |                 |                 |                 |                |       |              |              |         |               |          |  |  |  |  |
| ✓         | G0364A              | 100G LR4 1310 nm QSFP28           | QSFP28         |                   |                    |              |               |               |                    |               |                   |                |      |               |                  |               |                     |      |               |                     |                    |               |                 |               |                   |       |               |                 |                 |                 |                |       |              |              |         |               |          |  |  |  |  |
| ✓         | G0365A              | 100G LR4 Dual Rate 1310 nm QSFP28 | QSFP28         |                   |                    |              |               |               |                    |               |                   |                |      |               |                  |               |                     |      |               |                     |                    |               |                 |               |                   |       |               |                 |                 |                 |                |       |              |              |         |               |          |  |  |  |  |
| ✓         | G0369A              | 100G LR4 Dual Rate 1310 nm CFP4   | CFP4           |                   |                    |              |               |               |                    |               |                   |                |      |               |                  |               |                     |      |               |                     |                    |               |                 |               |                   |       |               |                 |                 |                 |                |       |              |              |         |               |          |  |  |  |  |

# Network Master Pro MT1000A Mainframe Specifications

|                     |   |
|---------------------|---|
| User Interfaces     |   |
| Display             | 9-inch active TFT display (800 × 480 pixels) and touch screen                 |
| Supported Languages | English, Chinese, Japanese, French, Russian, Spanish, Finnish, Korean, German |

|                       |  |
|-----------------------|--|
| Service Interfaces    |  |
| USB Data Interface    | MT1000A operates as host: USB 2.0 type A (2 ports)<br>MT1000A operates as device: USB 2.0 type Mini-B (1 port) |
| Ethernet Interface    | Ethernet 10M/100M/1000M, Connector: RJ45   |
| WLAN Interface*1      | IEEE 802.11 b/g/n  |
| Bluetooth Interface*1 | Bluetooth 2.1 +EDR   |

\*1: Available for certified countries and regions including USA, Canada, Japan and EU countries. Please visit the Anritsu web site for updated information.  
The Bluetooth® mark and logos are registered trademarks of Bluetooth SIG, Inc.

|                      |   |
|----------------------|---|
| Other Interfaces     |   |
| Audio Interface      | For connection of CTIA Standard head set<br>Connector: 3.5-mm diameter jack   |
| AUX Connector        | For connection of optional G0325A GPS receiver<br>With MT1000A-005: For connection of Optional MU100090A  |
| Built-in Loudspeaker | Monitors speech of voice channel<br>Output level: user-controlled from user Interface   |
| Internal Clock       | Accuracy: ±4.6 ppm or less, STRATUM3 compliant  |
| Ext. Clock Input     | For connection of external clock signals:<br>SETS (E1: 2.048 Mbps), BITS (DS1: 1.544 Mbps) or 2.048 MHz TTL signal in accordance with ITU-T G.703, 10 MHz<br>Connector: BNC (50Ω) |

|                     |  |                                    |
|---------------------|--|------------------------------------|
| Miscellaneous       |  |                                    |
| Battery             | 10.8 V rechargeable and replaceable intelligent Li-ion battery<br>Operating time: 1.5 hours (typ., in case of 100 GbE)<br>Charging time: 6 hours (Max.)<br>Remaining capacity indication: %  |                                    |
| Mains Adapter       | Input: 100 V(ac) to 240 V(ac), 50 Hz/60 Hz<br>Output: 18 V(dc), 3.62 A (max.)<br>Power Consumption: ≤65 W<br>With MT1000A-006*2<br>Input: 100 V(ac) to 240 V(ac), 50 Hz/60 Hz<br>Output: 18 V(dc), 6.6 A (max.)<br>Power Consumption: ≤120 W   |                                    |
| Dimensions and Mass | 257 (W) × 164 (H) × 82 (D) mm (Exclude Projection, MT1000A + MU100010A)<br>257 (W) × 164 (H) × 89 (D) mm (Exclude Projection, MT1000A + MU100011A)<br>2.7 kg (including MT1000A, MU100010A and battery)<br>2.7 kg (including MT1000A, MU100011A and battery)   |                                    |
| Environmental       | Temperature<br>Operating : 0°C to +50°C (non-condensing)<br>Charging: 0°C to +40°C (non-condensing)<br>Storage: -30°C to +60°C (non-condensing, without battery or AC adapter)<br>-20°C to +50°C (non-condensing, with battery and AC adapter)<br>Humidity<br>Operating: ≤85% RH (non-condensing)<br>Storage and Transportation: ≤90% RH (non-condensing, without battery and AC adapter)<br>Storage and Transportation: ≤85% RH (non-condensing, with battery and AC adapter) |                                    |
| CE                  | EMC  | 2014/30/EU, EN61326-1, EN61000-3-2 |
|                     | LVD  | 2014/35/EU, EN61010-1              |
|                     | RoHS   | 2011/65/EU, EN50581                |
| Laser Safety*3      | IEC 60825-1:2007 Class 1M<br>CFP4: 100GBASE-SR4<br>QSFP+: 40GBASE-SR4<br>QSFP28: 100GBASE-SR4<br>SFP28: 25GBASE-SR<br>IEC 60825-1:2007 Class 1<br>CFP4: 100GBASE-LR4<br>QSFP+: 40GBASE-LR4<br>QSFP28: 100GBASE-LR4<br>SFP28: 25GBASE-LR<br>SFP+: 100GBASE-SX/LX/ZX, 10GBASE-LR/ER/ZR<br>SFP: 4G FC (SX), 4G FC (LX), 4G FC (EX), OC-48 LR-1/STM L-16.1, OC-48 LR-2/STM L-16.2, 100BASE-FX/LX<br>FDA 21CFR1040.10 and 1040.11*4   |                                    |

\*2: MT1000A-006 is required for MU100011A.

\*3: Safety measures for laser products

This product complies with optical safety standards in 21CFR1040.10, 1040.11 and IEC 60825-1; the following descriptive labels are affixed to the product.

\*4: Excludes deviations caused by conformance to Laser Notice No. 50 dated June 24, 2007

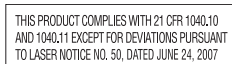

# Panel Layout

## Network Master Pro MT1000A

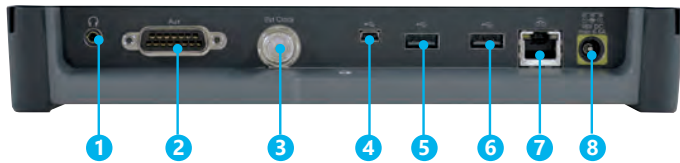
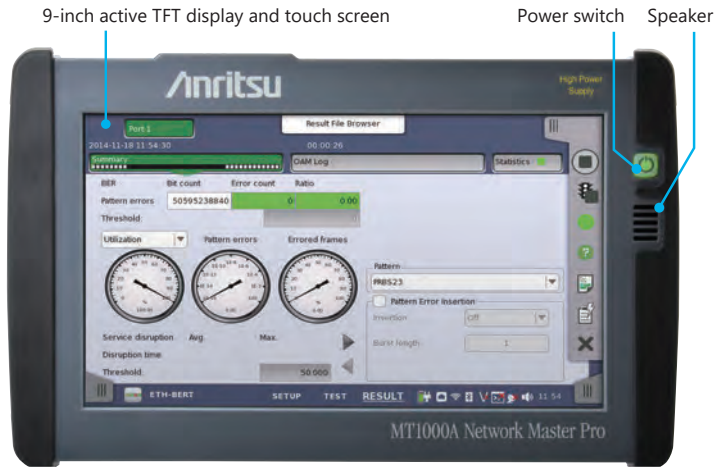

## 10G Multirate Module MU100010A

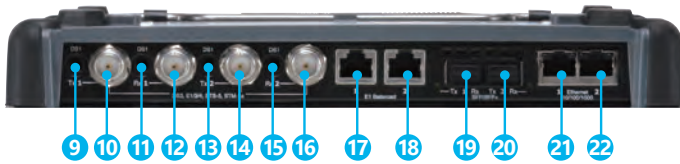

## 100G Multirate Module MU100011A

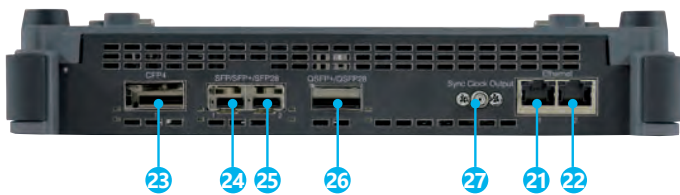

## High Performance GPS Disciplined Oscillator MU100090A

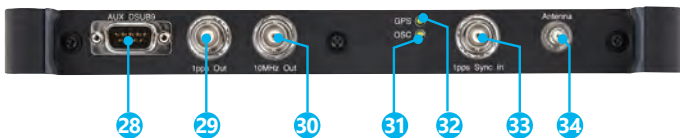

- 1 Audio (3.5ø: CTIA Standard)
- 2 AUX (D-SUB 15 pin)
- 3 Clock Input
- 4 USB Mini-B
- 5 USB A
- 6 USB A
- 7 Ethernet Service Interface
- 8 DC Input (18 Vdc)
- 9 Port 1, Tx Bantam (DS1)
- 10 Port 1, Tx BNC (E1, E3, E4, DS3, STM-1e, STS-3)
- 11 Port 1, Rx Bantam (DS1)
- 12 Port 1, Rx BNC (E1, E3, E4, DS3, STM-1e, STS-3)
- 13 Port 2, Tx Bantam (DS1)
- 14 Port 2, Tx BNC (E1, E3, E4, DS3, STM-1e, STS-3)
- 15 Port 2, Rx Bantam (DS1)
- 16 Port 2, Rx BNC (E1, E3, E4, DS3, STM-1e, STS-3)
- 17 Port 1, Tx/Rx RJ48 (E1 balanced)
- 18 Port 2, Tx/Rx RJ48 (E1 balanced)
- 19 Port 1, Tx/Rx SFP/SFP+ (OTN, Ethernet, eCPRI/RoE/CPRI/OBSAI, Fibre Channel, SDH/SONET optical)
- 20 Port 2, Tx/Rx SFP/SFP+ (OTN, Ethernet, eCPRI/RoE/CPRI/OBSAI, Fibre Channel, SDH/SONET optical)
- 21 Port 1, Tx/Rx RJ45 (Ethernet, eCPRI/RoE electrical)
- 22 Port 2, Tx/Rx RJ45 (Ethernet, eCPRI/RoE electrical)
- 23 Port 1, Tx/Rx CFP4 (OTN, Ethernet, eCPRI/RoE)
- 24 Port 1, Tx/Rx SFP/SFP+/SFP28 (OTN, Ethernet, eCPRI/RoE/CPRI/OBSAI, Fibre Channel, SDH/SONET)
- 25 Port 2, Tx/Rx SFP/SFP+/SFP28 (OTN, Ethernet, eCPRI/RoE/CPRI/OBSAI, Fibre Channel, SDH/SONET)
- 26 Port 1, Tx/Rx QSFP+/QSFP28 (OTN, Ethernet, eCPRI/RoE)
- 27 Port 1, Sync. Clock Output
- 28 AUX (D-SUB 9 pin)
- 29 1 pps Output (REF)
- 30 10 MHz Output
- 31 OCS LED
- 32 GPS received LED
- 33 1 pps Sync In
- 34 Antenna Input



Rechargeable and replaceable Li-ion battery

# Network Master Pro MT1000A Ordering Information

Please specify the model/order number, name and quantity when ordering.  
The names listed in the table below are Order Names. The actual name of the item may differ from the Order Name.

## Mainframe

| Model/Order No.             | Name                            |
|-----------------------------|---------------------------------|
| MT1000A                     | Network Master Pro              |
| <b>Standard Accessories</b> |                                 |
| MT1000A-006*1               | High Power Supply: Installed    |
|                             | Line Cord*2: 1 pc               |
| B0745A                      | Softcase: 1 pc                  |
| B0728A*3                    | Rear Panel kit: 1 pc            |
| G0385A*4                    | High Power AC Adaptor: 1 pc     |
| G0310A                      | Li-ion Battery: 1 pc            |
| Z1746A                      | Stylus: 1 pc                    |
| Z1747A*5                    | Carrying Strap: 1 pc            |
| Z1748A*6                    | Handle: 1 pc                    |
| Z1817A*7                    | Utilities ROM: 1 pc             |
| <b>Options</b>              |                                 |
| MT1000A-003*8               | Connectivity for WLAN/Bluetooth |
| MT1000A-005*9               | AUX I/O                         |

| Model/Order No.             | Name                             |
|-----------------------------|----------------------------------|
| <b>Optional Accessories</b> |                                  |
| B0691B*10                   | Hard Case                        |
| B0720A                      | Rear Panel                       |
| B0729A*11                   | Screw 1U                         |
| B0730A*11                   | Screw 2U                         |
| B0731A*11                   | Screw 3U                         |
| B0732A*12                   | Screw Kit                        |
| G0382A*13                   | Autofocus Video Inspection Probe |
| G0306B*13                   | Video Inspection Probe           |
| G0309A*4                    | AC Adapter                       |
| G0324A                      | Battery Charger                  |
| G0325A                      | GPS Receiver                     |
| J1569B                      | Car 12 Vdc Adapter               |
| J1667A*14                   | GPIB-USB Converter               |
| Z1821A*15                   | Utilities in USB Stick           |

### Softcase B0745A (Standard Accessory)

This bag with shoulder strap can hold the MT1000A with up to three installed modules.



### Hard Case B0691B

This strong plastic case can hold the MT1000A with up to two installed modules.  
462 (W) × 372 (H) × 207 (D) mm



## Module Configuration\*16

|           |  |  |
|-----------|--|--|
| 1 Module  |  |  |
| 2 Modules |  |  |
| 3 Modules |  |  |

\*1: The presence of the MT1000A-006 option can be recognized at the top right of the front panel. To retrofit to the already shipped item, please contact us.



Without MT1000A-006



With in MT1000A-006

\*2: One line cord is attached to the area to shipment.

\*3: Composed of B0720A, B0729A, B0730A and B0731A.

Refer to Module Composition for the module combination.

\*4: The MT1000A with MT1000A-006 can be used. Use the AC adapter when using the MT1000A without MT1000A-006 installed.

\*5: Shoulder strap for MT1000A.

\*6: Hand strap for MT1000A.

\*7: This DVD includes PDF files and formatting tools of each product's instruction manual (such as W3933AE, W3810AE, W3736AE, W3946AE).

\*8: Available for certified countries and regions including USA, Canada, Japan and EU countries. Please visit the Anritsu web site for updated information.

\*9: MT1000A-005 is required for MU100090A. To retrofit to the already shipped item, please contact us.

\*10: Can use module 1 to 2 in combination

\*11: Includes 4 bolts of same length

\*12: Includes B0729A, B0730A and B0731A

\*13: This fiberscope uses the VIP function in the MT1000A Utility menu.

Different tip types are used by the G0382A and G0306B.



G0382A



G0306B

\*14: J1667A is required for SCPI remote control via GPIB

\*15: Include MT1000A Operation Manual and the Remote Script Manual.

\*16: Any modular combination as shown in a figure.

\*17: Required if the transport module is not used rear cover.

# Network Master Pro MT1000A Ordering Information

## Transport Module

### 10G Multirate Module MU100010A

| Model/Order No.             | Name   |
|-----------------------------|--|
| MU100010A                   | 10G Multirate Module                                 |
| <b>Standard Accessories</b> |  |
| W3935AE                     | MT1000A Transport Module Quick Reference Guide: 1 pc |
| B0692A*1                    | ESD Box (for optical modules): 1 pc                  |

\*1: Up to four SFP+/SFPs can be stored.

#### Options\*2

| Model/Order No.      | Name                                |
|----------------------|-------------------------------------|
| <b>Low Rate</b>      |                                     |
| MU100010A-001*3      | Up to 2.7G Dual Channel             |
| <b>Ethernet</b>      |                                     |
| MU100010A-011        | Ethernet 10G Single Channel         |
| MU100010A-012        | Ethernet 10G Dual Channel           |
| MU100010A-020*4      | TCP Throughput                      |
| <b>OTN</b>           |                                     |
| MU100010A-051        | OTN 10G Single Channel              |
| MU100010A-052        | OTN 10G Dual Channel                |
| MU100010A-061*5      | ODU Multiplexing                    |
| MU100010A-062*5      | ODU Flex                            |
| <b>CPRI/OBSAI</b>    |                                     |
| MU100010A-071        | CPRI/OBSAI Up to 5G Dual Channel    |
| MU100010A-072        | CPRI/OBSAI 6G to 10G Single Channel |
| MU100010A-073        | CPRI/OBSAI 6G to 10G Dual Channel   |
| <b>Fibre Channel</b> |                                     |
| MU100010A-002        | FC 1G 2G 4G Dual Channel            |
| MU100010A-091        | FC 8G 10G Single Channel            |
| MU100010A-092        | FC 8G 10G Dual Channel              |
| <b>SDH/SONET</b>     |                                     |
| MU100010A-081        | STM-64 OC-192 Single Channel        |
| MU100010A-082        | STM-64 OC-192 Dual Channel          |

\*2: This option can be retrofitted.

The Model/Order No. of retrofit option is "-3\*\*".

Example

As a retrofit, MU100010A-001 Up to 2.7G Dual Channel becomes MU100010A-301 Up to 2.7G Dual Channel Retrofit. In addition, specify one of the following media along with the required option.

| Model/Order No. | Name                           |
|-----------------|--------------------------------|
| Z1849A          | DVD-ROM for Retrofit Options   |
| Z1850A          | USB Stick for Retrofit Options |

\*3: Includes OTN (OTU1), Ethernet (10 Mbps, 100 Mbps, 1 Gbps), SDH up to STM-16, SONET up to OC-48, PDH (E1, E3, E4), and DSn (DS1, DS3)

\*4: Requires that at least one of the following options is installed: MU100010A-001, MU100010A-011, MU100010A-012

\*5: Requires that at least one of the following options is installed: MU100010A-001, MU100010A-051, MU100010A-052

### 100G Multirate Module MU100011A

| Model/Order No.             | Name   |
|-----------------------------|--|
| MU100011A*6                 | 100G Multirate Module                                |
| <b>Standard accessories</b> |  |
| W3935AE                     | MT1000A Transport Module Quick Reference Guide: 1 pc |
| B0763A*7                    | ESD Box (for Optical modules): 1 pc                  |

\*6: MT1000A-006 is required for MU100011A.

\*7: One CFP4 plus either up to two QSFP28s or up to four SFP/SFP+s can be stored.

#### Options\*2

| Model/Order No.             | Name                                |
|-----------------------------|-------------------------------------|
| <b>Standard</b>             |                                     |
| MU100011A-001*8             | Up to 10G Single Channel            |
| MU100011A-003*8             | Up to 10G Dual Channel              |
| <b>Ethernet</b>             |                                     |
| MU100011A-013               | Ethernet 40G Single Channel         |
| MU100011A-015               | Ethernet 100G Single Channel        |
| MU100011A-017*9             | Ethernet 25G Single Channel         |
| MU100011A-020*10            | TCP Throughput                      |
| MU100011A-023*11            | RS-FEC for 100GBASE-SR4             |
| <b>OTN</b>                  |                                     |
| MU100011A-053               | OTN 40G Single Channel              |
| MU100011A-055               | OTN 100G Single Channel             |
| MU100011A-062*12            | ODU Flex                            |
| MU100011A-063*12            | ODU Multiplexing/Multi Stage        |
| <b>Fibre Channel</b>        |                                     |
| MU100011A-004               | Up to 10G FC Single Channel         |
| MU100011A-005               | Up to 10G FC Dual Channel           |
| MU100011A-091               | FC 16G Single Channel               |
| <b>eCPRI/RoE/CPRI/OBSAI</b> |                                     |
| MU100011A-071               | CPRI/OBSAI Up to 10G Single Channel |
| MU100011A-072               | CPRI/OBSAI Up to 10G Dual Channel   |
| MU100011A-073               | CPRI 12/25G Single Channel          |
| MU100011A-074               | CPRI 12/25G Dual Channel            |
| MU100011A-075*9, *13        | eCPRI/RoE 25G Dual Channel          |
| <b>SDH/SONET</b>            |                                     |
| MU100011A-083*14            | STM-256/OC-768 Client Signal        |

\*8: Only one of these option can be installed.

Included OTN(OTU1, OTU1e, OTU1f, OTU2, OTU2e, OTU2f), Ethernet up to 10 Gbps, SDH up to STM-64 and SONET up to OC-192.

\*9: FEC selectable On/Off.

\*10: Requires that at least one of the following option is installed: MU100011A-001, MU100011A-003

\*11: Requires to MU100011A-015

\*12: Requires that at least one of the following option is installed: MU100011A-001, MU100011A-003, MU100011A-053, MU100011A-055

\*13: Option supports eCPRI RoE protocol test only.

\*14: MU100011A does not have a physical interface of the option. The option is required for client signal mapped in the OTN.

### High Performance GPS Disciplined Oscillator MU100090A

| Model/Order No.             | Name  |
|-----------------------------|---|
| MU100090A*15                | High Performance GPS Disciplined Oscillator |
| <b>Standard Accessories</b> |   |
| J1705A                      | AUX Conversion Adaptor                      |
| J1706A                      | GPS Antenna                                 |
| J1710A                      | BNC Cable (20 cm) × 2                       |

\*15: Excellent Eco Product non-compliant.

MT1000A-005 is required for MU100090A.

# Network Master Pro MT1000A Ordering Information

## Optional Accessories for Transport Module

| Model/Order No.          | Name  |
|--------------------------|---|
| <b>Operation Manuals</b> |   |
| W3933AE                  | MT1000A Transport Module Operation Manual         |
| W3736AE                  | MT1000A/MT1100A Remote Scripting Operation Manual |
| <b>Optical Module</b>    |   |
| G0332A                   | 100M FX 1310 nm MM SFP                            |
| G0319A                   | Up to 2.7G 1310 nm 15 km SFP                      |
| G0320A                   | Up to 2.7G 1310 nm 40 km SFP                      |
| G0321A                   | Up to 2.7G 1550 nm 80 km SFP                      |
| G0328A                   | 1G/2G/4G FC 850 nm SFP                            |
| G0322A                   | 1G/2G/4G FC 1310 nm SFP                           |
| G0323A                   | 1G/2G/4G FC 1550 nm SFP                           |
| G0315A                   | 10G LR/LW 1310 nm SFP+                            |
| G0316A                   | 10G ER/EW 1550 nm 40 km SFP+                      |
| G0318A                   | 10G ZR/ZW 1550 nm 80 km SFP+                      |
| G0329A                   | 10G LR 1310 nm SFP+                               |
| G0356A                   | 8G FC/10G SR 850 nm SFP+                          |
| G0386A                   | 16GFC SR 850 nm SFP+                              |
| G0387A                   | 16GFC LR 1310 nm SFP+                             |
| G0388A                   | 25G SR 850 nm SFP28                               |
| G0389A                   | 25G LR 1310 nm SFP28                              |
| G0359A                   | 40G SR4 850 nm QSFP+                              |
| G0334A                   | 40G LR4 1310 nm QSFP+                             |
| G0366A                   | 100G SR4 850 nm QSFP28                            |
| G0364A                   | 100G LR4 1310 nm QSFP28                           |
| G0365A                   | 100G LR4 Dual Rate 1310 nm QSFP28                 |
| G0369A                   | 100G LR4 Dual Rate 1310 nm CFP4                   |
| <b>Cables</b>            |   |
| J1571A                   | Optical Cable SM LC/PC to SC/PC 3 m               |
| J1575A                   | Optical Cable SM LC/PC to FC/PC 3 m               |
| J1579A                   | Optical Cable SM LC/PC to LC/PC 3 m               |
| J1581A                   | Optical Cable MM LC/PC to LC/PC 3 m               |
| J1583A                   | Optical Attenuator 10 dB LC/PC to LC/PC           |
| J1584A                   | RJ45 Cable 3 m                                    |
| J1585A*1                 | RJ48 to Crocodile Clips Cable 3 m                 |
| J1586A*1                 | RJ48 to Crocodile Clips Cable 20 dB ATT 3 m       |
| J1588A*2                 | BNC Cable 2.5 m                                   |
| J1589A*2                 | BNC to 1.6/5.6 Cable 2.5 m                        |
| J1591A*1                 | RJ48 to Two 3-pin Banana Plug Cable 2.5 m         |
| J1597A*1                 | RJ48 Balanced PDH Cable Crossed 3 m               |
| J1598A*3                 | Bantam Cable 3 m                                  |
| J1710A*4                 | BNC Cable 0.2 m                                   |
| J0127B*4                 | COAXIAL CORD, 2.0 M                               |

\*1: E1 interface cable.

\*2: E1, E3, E4, DS3, STM-1e, STS-3 interface cable. Impedance: 75Ω

\*3: DS1 interface cable.

\*4: 50Ω impedance cable for MU100090A and main-frame external clock input connector

## Maintenance Service

| Model/Order No. | Name                              |
|-----------------|-----------------------------------|
| MT1000A-ES210   | 2 Years Extended Warranty Service |
| MT1000A-ES310   | 3 Years Extended Warranty Service |
| MT1000A-ES510   | 5 Years Extended Warranty Service |
| MU100010A-ES210 | 2 Years Extended Warranty Service |
| MU100010A-ES310 | 3 Years Extended Warranty Service |
| MU100010A-ES510 | 5 Years Extended Warranty Service |
| MU100011A-ES210 | 2 Years Extended Warranty Service |
| MU100011A-ES310 | 3 Years Extended Warranty Service |
| MU100011A-ES510 | 5 Years Extended Warranty Service |
| MU100090A-ES210 | 2 Years Extended Warranty Service |
| MU100090A-ES310 | 3 Years Extended Warranty Service |
| MU100090A-ES510 | 5 Years Extended Warranty Service |

# Network Master Pro MT1000A Ordering Information

---

## Remote Software Service

The following licenses must be purchased to use the MX109020A Site Over Remote Access.

### Mainframe Option License

| Model/Order No. | Name                            |
|-----------------|---------------------------------|
| MT1000A-003*1   | WLAN/Bluetooth Connect          |
| MT1000A-011*2   | Site Over Remote Access Connect |

\*1: Available for certified countries and regions including USA, Canada, Japan and EU countries. Please visit the Anritsu web site for updated information.  
The Bluetooth® mark and logos are registered trademarks of Bluetooth SIG, Inc.

\*2: Validity period is unlimited. An open TCP port may be required to allow the MT1000A to be connected from an in-company LAN to MX109020A, depending on the LAN security policy.

### Subscription Option License

| Model/Order No.         | Name                                    |
|-------------------------|---|
| MX109020A*3, *5, *6, *7 | Site Over Remote Access Basic License   |
| MX109020A-TL001*3, *4   | Site Over Remote Access 1 Year License  |
| MX109020A-001*5         | Site Over Remote Access 8 Units         |
| MX109020A-002*5         | Site Over Remote Access Unlimited Units |

\*3: We recommend purchasing a 1-year license in addition to the basic license.

\*4: When extending the usage period, we recommend purchasing in 1-year license periods

\*5: Up to two measuring instruments can be remotely controlled simultaneously with the basic license.

This number can be increased to up to 8 units by purchasing the MX109020A-001 option, and up to 100 units by purchasing the MX109020A-002 option.

\*6: You must agree to the service terms before purchasing SORA.

Refer to the service terms at the following URL: <https://www.anritsu.com/en-AU/test-measurement/support/downloads/manuals/dwl20059>

\*7: This product cannot be used in some regions and countries; please read the service terms for more details.



# Network Master Pro MT1000A

## Related Products

### Network Master Pro MT1000A



|   |           |
|---|-----------|
| OTDR Module 1310/1550 nm SMF              | MU100020A |
| OTDR Module 1310/1550/850/1300 nm SMF/MMF | MU100021A |
| OTDR Module 1310/1550/1625 nm SMF         | MU100022A |
| OTDR Module 1310/1550/1650 nm SMF         | MU100023A |

Installing an OTDR Module MU100020A/MU100021A/MU100022A/MU100023A provides the OTDR functions required for optical fiber I&M. Work efficiency is increased by all-in-one support for optical fiber tests and data communications network commissioning. I&M tests of 1.5 Mbps to 100 Gbps communications networks can be executed by simultaneously installing the MU100010A or MU100011A. In addition to supporting Ethernet, OTN, etc., networks, Mobile base station CPRI and OBSAI, as well as SyncE protocols are also supported.

### CPRI RF Module MU100040B

Installing the CPRI RF Module MU100040B in the MT1000A supports analysis of IQ signal frequency characteristics included in CPRI signals between the LTE base station RRH and BBU. This can be used to check operation of the RRH after installation. MU100040B supported BBU emulation for RRH.



### Network Master Flex MT1100A



All-in-one, up to 4-port transport tester supporting from 1.5 Mbps to 100 Gbps including OTN, Ethernet, eCPRI/RoE/CPRI/OBSAI, Fibre Channel, SDH/SONET and PDH/DSn.



### MT9090A Series



#### μOTDR Module MU909014/15

Compact OTDR for full automatic verification of optical networks, FTTH-PON, Metro and Core.



#### Gigabit Ethernet Module MU909060A

Dedicated field test solution for installation and troubleshooting Ethernet links in access networks.



### CMA5 Series

#### Light Source/Optical Power Meter

For optical fiber installation and maintenance.



### ACCESS Master MT9085 Series

#### For WAN/MFH/DCI/FTTH Optical Fiber I&M

- Improved operability with powerful synergy of 8-inch touchscreen and hardware keys
- At-a-glance Pass/Fail evaluation using Fiber Visualizer
- All OTDR, OLTS, and Visible Light Source operations on one screen
- Short event dead zone of  $\leq 0.8$  m and high dynamic range of 46 dB max.
- Power meter option for measuring optical power up to +30 dBm







- **United States**

**Anritsu Americas Sales Company**

450 Century Parkway, Suite 190, Allen, TX 75013 U.S.A.  
Phone: +1-800-Anritsu (1-800-267-4878)

- **Canada**

**Anritsu Electronics Ltd.**

700 Silver Seven Road, Suite 120, Kanata,  
Ontario K2V 1C3, Canada  
Phone: +1-613-591-2003  
Fax: +1-613-591-1006

- **Brazil**

**Anritsu Elettronica Ltda.**

Praça Amadeu Amaral, 27 - 1 Andar  
01327-010 - Bela Vista - Sao Paulo - SP, Brazil  
Phone: +55-11-3283-2511  
Fax: +55-11-3288-6940

- **Mexico**

**Anritsu Company, S.A. de C.V.**

Bldv Miguel de Cervantes Saavedra #169 Piso 1, Col. Granada  
Mexico, Ciudad de Mexico, 11520, MEXICO  
Phone: +52-55-4169-7104

- **United Kingdom**

**Anritsu EMEA Ltd.**

200 Capability Green, Luton, Bedfordshire, LU1 3LU, U.K.  
Phone: +44-1582-433200  
Fax: +44-1582-731303

- **France**

**Anritsu S.A.**

12 avenue du Québec, Bâtiment Iris 1- Silic 612,  
91140 VILLEBON SUR YVETTE, France  
Phone: +33-1-60-92-15-50  
Fax: +33-1-64-46-10-65

- **Germany**

**Anritsu GmbH**

Nemetschek Haus, Konrad-Zuse-Platz 1,  
81829 München, Germany  
Phone: +49-89-442308-0  
Fax: +49-89-442308-55

- **Italy**

**Anritsu S.r.l.**

Via Elio Vittorini 129, 00144 Roma, Italy  
Phone: +39-6-509-9711  
Fax: +39-6-502-2425

- **Sweden**

**Anritsu AB**

Isafjordsgatan 32C, 164 40 KISTA, Sweden  
Phone: +46-8-534-707-00

- **Finland**

**Anritsu AB**

Teknobulevardi 3-5, FI-01530 VANTAA, Finland  
Phone: +358-20-741-8100  
Fax: +358-20-741-8111

- **Denmark**

**Anritsu A/S**

c/o Regus Winghouse, Ørestads Boulevard 73, 4th floor,  
2300 Copenhagen S, Denmark  
Phone: +45-7211-2200

- **Russia**

**Anritsu EMEA Ltd.**

**Representation Office in Russia**

Tverskaya str. 16/2, bld. 1, 7th floor.  
Moscow, 125009, Russia  
Phone: +7-495-363-1694  
Fax: +7-495-935-8962

- **Spain**

**Anritsu EMEA Ltd.**

**Representation Office in Spain**

Paseo de la Castellana, 141. Planta 5, Edificio Cuzco IV  
28046, Madrid, Spain  
Phone: +34-91-572-6761

- **United Arab Emirates**

**Anritsu EMEA Ltd.**

**Dubai Liaison Office**

902, Aurora Tower, P O Box: 500311- Dubai Internet City  
Dubai, United Arab Emirates  
Phone: +971-4-3758479  
Fax: +971-4-4249036

- **India**

**Anritsu India Private Limited**

6th Floor, Indiqube ETA, No.38/4, Adjacent to EMC2,  
Doddanekundi, Outer Ring Road, Bengaluru – 560048, India  
Phone: +91-80-6728-1300  
Fax: +91-80-6728-1301

- **Singapore**

**Anritsu Pte. Ltd.**

11 Chang Charn Road, #04-01, Shriro House, Singapore 159640  
Phone: +65-6282-2400  
Fax: +65-6282-2533

- **Vietnam**

**Anritsu Company Limited**

Room No. 1635, 16th Floor, ICON 4 Tower, 243A De La Thanh Street,  
Lang Thuong Ward, Dong Da District, Hanoi, Vietnam  
Phone: +84-24-3760-6216  
Fax: +84-24-6266-2608

- **P.R. China (Shanghai)**

**Anritsu (China) Co., Ltd.**

Room 2701-2705, Tower A, New Caohejing International  
Business Center No. 391 Gui Ping Road Shanghai, 200233, P.R. China  
Phone: +86-21-6237-0898  
Fax: +86-21-6237-0899

- **P.R. China (Hong Kong)**

**Anritsu Company Ltd.**

Unit 1006-7, 10/F., Greenfield Tower, Concordia Plaza,  
No. 1 Science Museum Road, Tsim Sha Tsui East,  
Kowloon, Hong Kong, P.R. China  
Phone: +852-2301-4980  
Fax: +852-2301-3545

- **Japan**

**Anritsu Corporation**

8-5, Tamura-cho, Atsugi-shi, Kanagawa, 243-0016 Japan  
Phone: +81-46-296-6509  
Fax: +81-46-225-8352

- **Korea**

**Anritsu Corporation, Ltd.**

5FL, 235 Pangyoeyeok-ro, Bundang-gu, Seongnam-si,  
Gyeonggi-do, 13494 Korea  
Phone: +82-31-696-7750  
Fax: +82-31-696-7751

- **Australia**

**Anritsu Pty. Ltd.**

Unit 20, 21-35 Ricketts Road, Mount Waverley, Victoria 3149, Australia  
Phone: +61-3-9558-8177  
Fax: +61-3-9558-8255

- **Taiwan**

**Anritsu Company Inc.**

7F, No. 316, Sec. 1, NeiHu Rd., Taipei 114, Taiwan  
Phone: +886-2-8751-1816  
Fax: +886-2-8751-1817